



客户-订单号:33315-2317940
文件名: D_1863709_weaver
订单量:5pcs 包装量:5pcs
包装日期:2023-06-05

DO NOT EAT
DESICCANT
GEL
THROW AWAY
DO NOT EAT
DESICCANT

MODULAR MATTER

→ @ohian

REWIRE YOUR PRINTS!



FRAGILE
HANDLE WITH CARE

MODULAR MATTER – Rewire your Prints!

A Situated and Annotated Manual

1) Introduction

1.1) Introducing MODULAR MATTER

- Modular Synthesis
- Desktop Publishing
- Re-thinking Desktop Publishing through the concept of Modular Synthesis

1.2) Introducing the Situated and Annotated Manual

- Why a Manual?
- Why Annotated?
- Why Situated?

2) The Context around the Tool

2.1) Graphic Design and Book Making

2.2) Proprietary Tools and their Implications

- Tools shape Practice
- How Proprietary Tools shape Graphic Design and Printed Matter

3) Counter Strategies: Practice shapes Tools

3.1) Hacking and Bending

3.2) Alternative Tools

3.3) Make your own Tools

4) MODULAR MATTER: Technical Instructions

4.1) Overall Setup

4.2) Single Modules

- Dynamic Glyph
- Friction Label
- Future Relics
- Weaver
- Whoosh
- Emergent Matter

4.3) Reference data sheet

5) MODULAR MATTER – Rewire your Prints!

References

Dear graphic designers, print publishers
and creative makers!

This handbook will introduce you to MODULAR MATTER, a tool that is being developed to playfully re-think and re-imagine the practice of Desktop Publishing and print design. You will become familiar with the device itself and learn about its utilization and functionality, enabling you to work, play and make with it.

Moreover, this Situated and Annotated Manual aims to explain the intention and purpose of MODULAR MATTER and its making process. While critically elaborating on the socio-technical context and practice around the tool, I invite you to think along and hopefully find some inspiration and encouragements for your own future makings!

1) Introduction

The scope of this *Situated and Annotated Manual* is to introduce **MODULAR MATTER**, explaining in detail how the tool is built, how it operates and how it can be put to use. It investigates the practical and theoretical context around the tool, hoping to unravel its purpose and meaning.

MODULAR MATTER – Rewire your Prints! addresses graphic designers and other creatives who are used to work with traditional *Desktop Publishing* software and devices. Its experimental and modular setup may help to break open those long-established habits and lead to unexpected designs and meaningful printed outcome, for example in the form of small posters or even simple publications. Moreover, the counter approach of the tool hopefully sparks questions and critical conversations about the current status quo of this field, initiating essential reflections and re-imaginings of the creative practice and its tool ecologies.

By unfolding and analyzing these aspects, the handbook aims to explore how the concept of *Modular Synthesis* may help to re-think *Desktop Publishing* and provide new impulses for graphic designers and creative makers alike.

1.1) Introducing MODULAR MATTER

The basic idea for **MODULAR MATTER** is simple: It uses the well-known concept of *Modular Synthesis*, but instead of staying in the original context of *sound*, the operating modes are translated and applied to the realm of print publishing.

Modular Synthesis

A modular synthesizer is an electronic instrument that generates electronic sounds. It consists of many different and independent physical modules that can be combined in any number of ways to create and manipulate sound output.

Each module performs a certain operation that can be controlled by adjustable components like switches, sliders and patch cables. (Fig. 1) The output of one module can be used as the input for another module, which allows for creative combinations, loops and unexpected outcome. (Fig. 2)

In order to apply this tangible and modular way of sound production to print publishing, it is important to understand how printed matter is usually created.

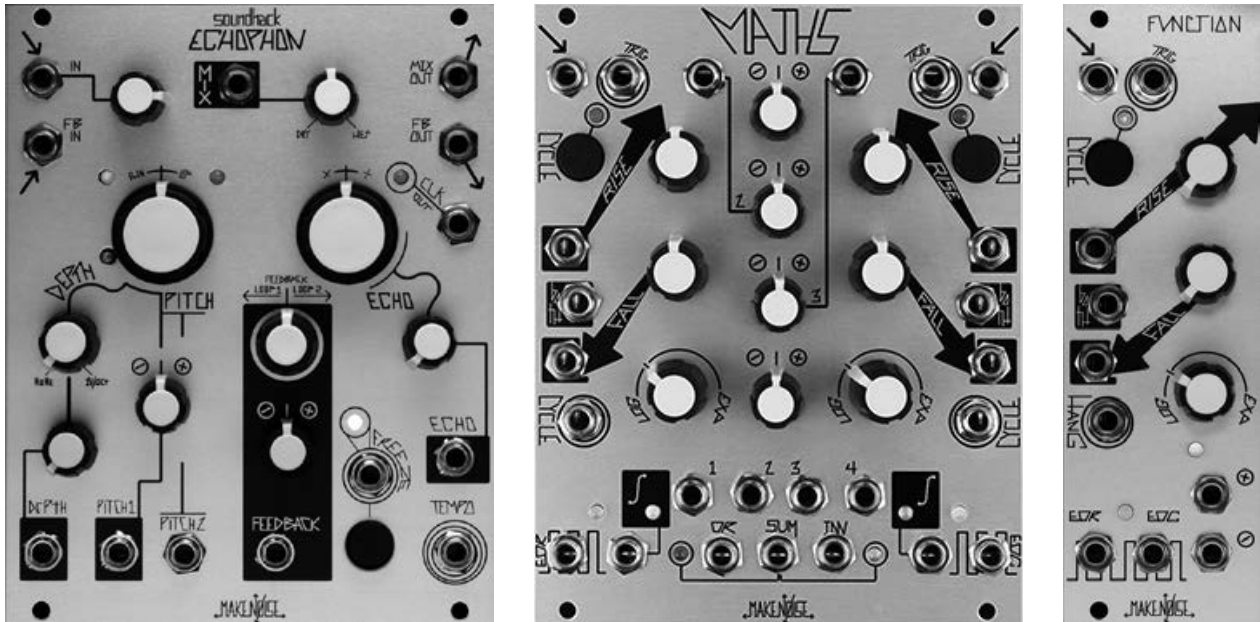

Fig. 1: Synthesizer modules *Echophon*, *MATHS* and *Function* by Make Noise. The *Echophon* module, for example, uses incoming sound signal to create a pitch shifting echo with smooth time modulation. (Make Noise, no date)

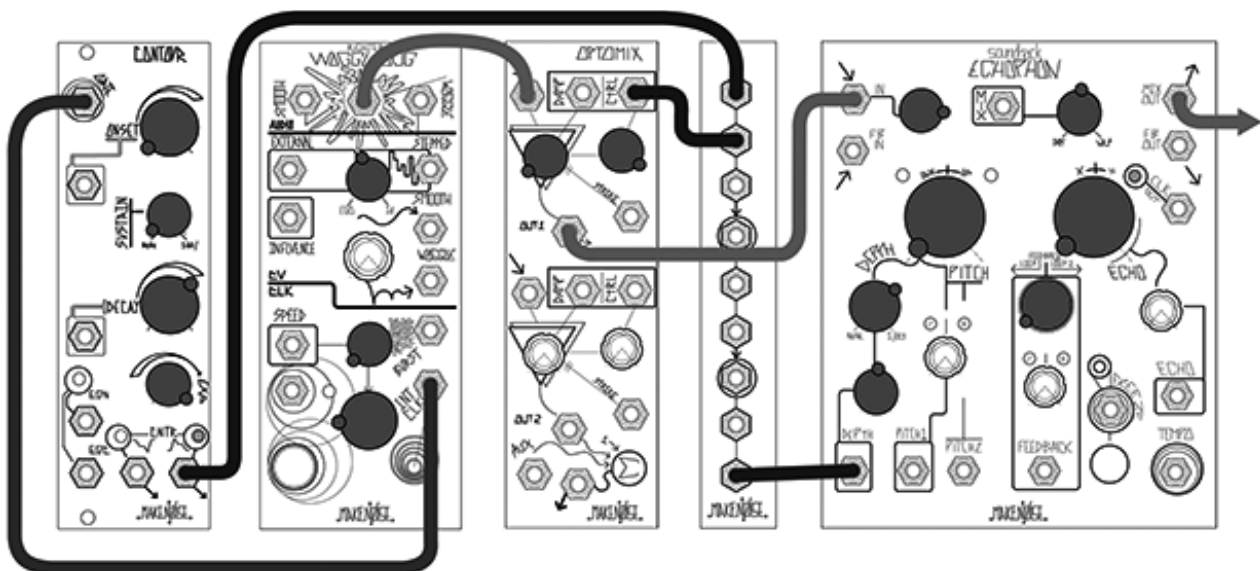

Fig. 2: Patch idea for the *Echophon* module by Make Noise. This particular setup is designed for processing percussive sounds and combines the modules *Contour*, *WobbleBug*, *Optomix* and *Echophon*. (Make Noise, no date)

Desktop Publishing

Since the expansion of the personal computer, most graphic designers are used to *Desktop Publishing*, a technology that is based on a combination of hardware and software components to create printable outcome.

The whole operation involves 1) *input devices*, such as keyboard, camera and scanner, 2) *control devices* such as mouse and keyboard and 3) *output devices* such as a printer. It also relies on a *Graphical User Interface (GUI)* and *WYSIWYG (what you see is what you get)* software (Fig. 3). For many graphic designers these tools and processes seem so natural, that it is hard to even imagine a different setup or workflow.

Re-thinking Desktop Publishing through the concept of Modular Synthesis

MODULAR MATTER is an attempt to re-think this print design workflow. Its experimental and modular setup offers an unconventional approach to perform operations on text and images in order to create printed matter. Inspired by the structure of *Modular Synthesis*, the process of *Desktop Publishing* is re-imagined as a number of independent and combinable hardware modules. Each module is performing a specific operation and can be regulated by an operation-specific, physical interface.

Different module types can be connected in order to create and transform typographical and pictorial material: 1) *Input modules* that generate text or images and 2) several *transform modules* that process and manipulate the input, are connected to 3) the *output module*, a printer, that produces the final outcome of the workflow. This setup is accompanied by 4) a *preview module* for accurate representation of the process. (Fig. 4)

In chapter 3) you will find a detailed description of the technical infrastructure of *MODULAR MATTER*, as well as one example for a transform module.

Introducing *MODULAR MATTER* and its purpose to an audience of graphic designers and other creatives requires a specific mode of address. With this in mind, the format of the *Situated and Annotated Manual*, which will be introduced in the following section, proposes a context-related and audience-specific way to document and present the tool.

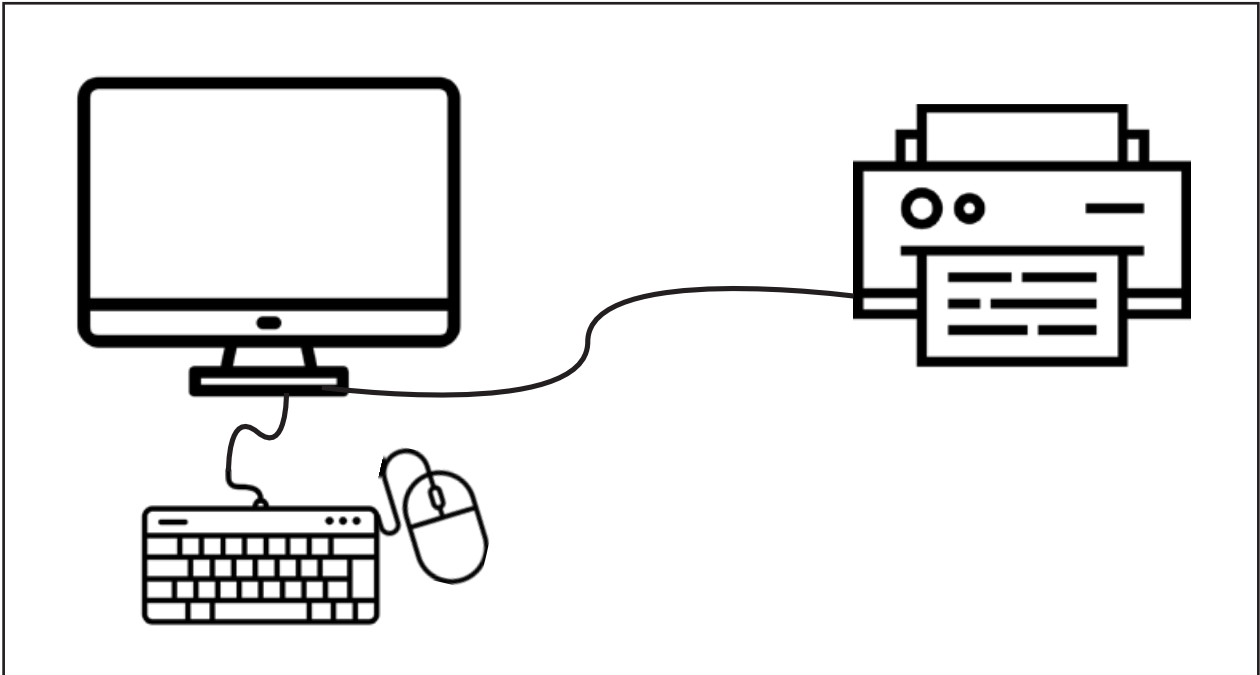

Fig. 3: Traditional *Desktop Publishing* setup: A personal computer with a *Graphical User Interface*, a keyboard and mouse as *input and control devices*, and a printer as *output device*

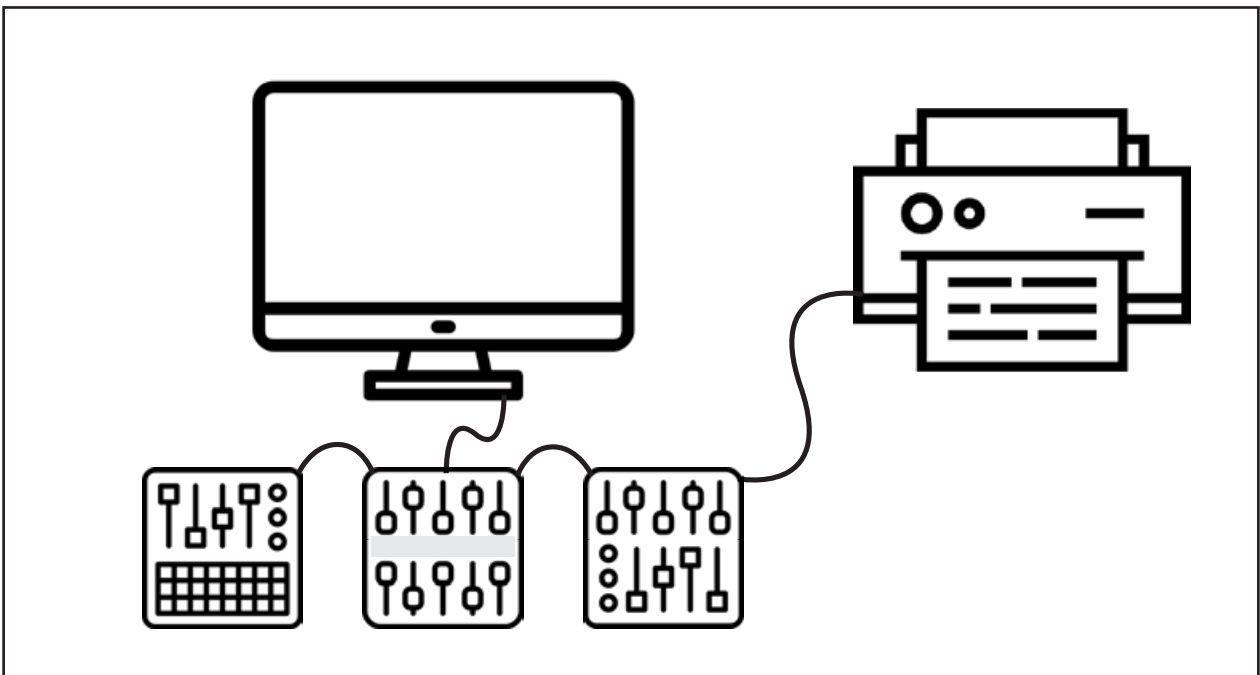

Fig. 4: First draft for the infrastructure of *MODULAR MATTER*: A screen as *preview module*, a printer as *output module*, and three *input and transform modules*

1.2) Introducing the Situated and Annotated Manual

Why a Manual?

A manual is a common format to give detailed and technical information and instructions. The term *manual* comes from the Latin and translates to “of the hand” or “by the hand”, which implies a practical, hands-on approach. Certainly, this format allows for complete and in-depth explanations on how *MODULAR MATTER* works and how to use it.

However, the development and usage of the tool bring technical challenges and demand formal descriptions based on standardized technical terms. This comes with the risk of inaccessibility and could make the tool less approachable for some readers.

Why Annotated?

To prevent this from happening and to subvert the strictness of the technical manual, a more intimate and playful layer will be added. 😊 Eventually, the aim of the *Annotated Manual* is to cover the complex technicalities of the tool while being inviting and understandable for all readers at the same time.

- 😊 *Like so! Hi, it's me, the author of this text. I will use these annotations to weave in some personal anecdotes, informal notes, sketches and hints. Sometimes it can be overwhelming to read a manual, especially when technical terms and descriptions are taken for granted. In those moments you can switch to this layer, where technical standards will be declined in favor of a more relatable and accessible account.*

Why Situated?

Another important aspect to be present in this text is the context around the tool. The idea and implementation of the project are strongly influenced by personal experience and a background in graphic design and *Desktop Publishing*. Furthermore, the making process speaks to the practical and theoretical discourse around tools and how they shape practice. 😊

This situates the tool in a specific field that is relatable for many other creators and makers. Writing about the context, addressing references and relationalities, will help to explain the purpose and relevance of *MODULAR MATTER*.

- 😊 *As a trained graphic designer, mainly concerned with printed matter and book making, I have been familiar with Desktop Publishing for more than ten years and it has been very present in all my making, designing and publishing processes. I never really reflected on the influence my toolkit and workflow might have on my practice. Recently, I started to experiment with electronics and physical computing, imagining ways to incorporate these new explorations into my print practice. With the making of MODULAR MATTER I am trying to consciously reflect on my own tool ecologies.*

Before taking a closer look at the tool itself, the following chapter aims to gather and link those observations, trying to delineate the conditions, mechanisms and cultural habits of the environment it is situated in.

2) The context around the Tool

MODULAR MATTER is embedded in the context of graphic design and printed matter, and at the same time it speaks to a larger discourse and theory about tools and practice. Both perspectives, which will be addressed in this chapter, have not only shaped the general idea for the tool, but as well informed and inspired its making process.

2.1) Graphic Design and Book Making

Handling a book or any other printed object is a tangible, embodied experience. Many graphic designers, who are concerned with book making, share an understanding and awareness of materiality. They appreciate the body of the book, the touch and feel of the paper, the scent of freshly printed ink and the sound of flipping pages. Anatomical terms that describe the book, such as *body*, *spine*, *head* and *foot*, already imply the significance of physicality.

Before the Digital Era, typesetting and composition used to be very hands-on, manual operations that were directly connected to the printing process. Nowadays, the act of *making* the book (and printed matter in general) is in large part digital. Most graphic design is done with a personal computer and *Desktop Publishing* software. The actual materialization, the emergence of printed matter, is often not even part of the designer's process. Instead it will be taken care of separately by printers and bookbinders.

With the focus on the physical end product, the conditions and implications that come with the digital workflow and tools are often overlooked or even concealed. Therefore, it is necessary to take a closer look at this digital practice, trying to reveal what it actually entails.

The tools, interfaces and control devices that most graphic designers use in their day-to-day work include *Apple's* devices (e.g. *MacBook*, *iMac*, *iPhone*, *iPad*), *Adobe's* software portfolio (e.g. *Photoshop* and *InDesign*), *Google's* search engine, as well as *Meta Platforms'* products and applications (e.g. *Facebook*, *Instagram* and *WhatsApp*). 😊

😊 Let's face the reality: I am typing this very text on a MacBook right now, and yes, I do use InDesign for the layout, and yes, probably I will also post MODULAR MATTER on Instagram - using my iPhone of course!

When working in the graphic design field, it seems virtually impossible to not use the products of big tech and media companies. (Pater, 2021, p. 378) In fact, it appears so easy and natural, so common and obvious to use these tools, that it is hardly ever questioned. Quite the contrary: More often than not these proprietary products are even glorified as the golden standard, best practice or just as trendy and hip.

This tendency may be caused by their flawless appearance and functionality. As Femke Snelting, member of the non-profit association for art and media *Constant* and co-initiator of *Open Source Publishing (OSP)*, elaborates in *Awkward gestures: designing with Free Software*,

“Apple promotes its operating system with ‘*software that just works*’ (apparently you don’t need to worry about it at all) and also Adobe makes every effort to push the simulations and algorithms, the monstrous machinery, that define the software, into the background. Recognizable patterns are inventively arranged in well-organized and reliable interfaces, minimizing their own presence and creating a feel of naturalness.” (Snelting, 2008, para. 2)

Whilst this may look like a desirable condition at first glance, there are some implications which should be taken into consideration, even though they are difficult to detect. Graphic designers throughout large companies, creative studios, institutions and academia use tools that are designed to vanish, to disappear, to hide in plain sight. A compilation of commercial hardware and software maintain a familiar and seamless work environment that doesn’t require technical knowledge beyond the user interface or any further understanding of the processes at work. Everyone knows how to use the tools, and no one understands how they operate. This dependency on proprietary tools is not problematized enough in the creative field and can expedite instrumentalization and a lack of agency.

2.2) Proprietary Tools and their Implications

In the 1960s a conversation around tools and their implications was initiated, and since then a number of media theorists and creative makers have contributed to the discourse. In order to properly address the specifics of graphic design tools and their influence on printed matter, it is important to look at some key findings of this previous research.

Tools shape Practice

In the publication *Understanding Media: The Extensions of Man*, Marshall McLuhan establishes the idea that “the medium is the message” (McLuhan, 1964, pp. 1-18) and with that becomes one of the early advocates for media theory. He suggests that every content exists in a specific form, a medium, that shapes the (perception of the) message. Therefore, the medium has to be studied: “If you don’t know the medium, you don’t know the message,” his colleague John Culkin concludes (Culkin, 1967, p. 52).

McLuhan uses the terms *form*, *medium* and *technology* interchangeably to distinguish the *carrier* of the message from the *content*. In an article about McLuhan's theories, John Culkin adds another term to that list and states: "We shape our tools and thereafter they shape us," a thought that clearly derives from his friends' theory (Culkin, 1967, p. 70).

While McLuhan and Culkin refer to the new media of their time (television, newspapers, magazines and cinema), in 2013 Lev Manovich updates the discourse with a contemporary perspective and claims: "the software is the message", saying that "software re-adjusts and re-shapes everything it is applied to—or at least, it has a potential to do this." (Manovich, 2013a)

The cumulation of these thoughts suggests that tools, both analog and digital, significantly impact and control human perception. They shape the world, which is why they must not be ignored nor underestimated, but rather be used and built with care and consciousness.

Using these ideas as a point of departure, the following section will take a closer look at the specifics of proprietary tools and their impact on graphic design practice.

How Proprietary Tools shape Graphic Design and Printed Matter

Based on the observation that most graphic designers use proprietary tools on a daily basis, there are two pending questions that so far remain unanswered: Firstly, *How do proprietary tools shape graphic design practice?*, and secondly, *Who shapes these tools?*

Looking at the graphic design field it is hard to deny a general universalization of tools in use. During their design education most students get introduced to the products, and in the workplace they are often considered the industry standard. This holds true for hardware and software choices as well as any other devices and applications. These tools, privately owned by very few, large companies that answer to shareholders, set the norms. Instead of providing a wide variety of options, the large corporate players establish standards for infrastructure, protocols, interfaces and design options. These norms function as guarantee for the monopoly position, since it is difficult for niche products to seamlessly integrate themselves into the pre-specified workflow.

While the idea of universalization may stem from the socialist ideal to create products accessible for everyone, here quite the opposite effect takes place: Since the tools require financial privilege as well as some technical knowledge and equipment, they are distributed unequally. (Pater, 2021, p. 389) Those creatives who can afford working with proprietary tools are encouraged to make them integral parts of their practice, which excludes others from participation.

Despite their ubiquitous presence, the users are usually not invited to help create and design the tools according to their needs and wishes. Instead of aiming for a participatory design approach, most decisions for current and future developments are made by a few (mostly white, cis male) developers. Additionally, many choices are based on numbers and statistics, aiming to make the most profit and create economic value. Other perspectives, such as creative, imaginary and especially marginalized ones, are often excluded from this process.

Regardless of these problems and considerations, many creatives feel reassured in their practice. All tools they use look similar and function very much alike. The users feel confident, nonchalantly switching from one application to the other, comforted by the fact that they know how to behave in

this ever so familiar environment. While feeling very much at home in their proprietary toolkit, many graphic designers tend to underestimate the implicit effects that the economical conditions and ethical issues have on their creative independence and practice as a whole.

Far too often efficiency and productivity are prioritized over creativity and out of the box thinking. Similar to a navigation system, that is suggesting the main roads and fast lanes instead of a detour to explore the hidden paths and bumpy off-roads, proprietary tools support a streamlined process, overlooking the beauty and potential of the outskirts. This leads to an underrepresentation of vernacular perspectives and results in often “sleek” and homogeneous visual outcome.

The uniform tool landscape in graphic design very much determines not only the technical setup and infrastructure, but also the division of labour and even the actual outcome. (Snelting, 2008, para. 5) All design options are predefined by the applications, and even though they may seem to offer endless possibilities and combinations, in the end they shape and limit what is (im)possible. 😊

😊 *This may sound a bit abstract, so let's look at an example: In most layout programs you have to decide the size and format of the canvas: There are some standard options to choose from, for example DIN formats, and you can even define a custom format with specific measurements. But have you ever imagined a file (or even a book) in a custom shape, such as a triangle or any organic shape? Is that even possible? Why not?*

These regulations restrict the independence of creative makers and limit their practice and potential. As stated on the website of *The Screenless Office*, a project developed by Brendan Howell to consume digital media without a display:

“These interfaces have become so embedded in our conception of reality that we now have a crisis of the imagination, where it is difficult to even think of anything different.” (Howell and Pogorzelskiy, no date)

The lack of diversity in tools causes a universalization of aesthetics, and even worse, it impacts the perception, experience and imagination of creatives as well. The possibilities of the tool are what is considered possible, and the tool's limitations define the boundaries of what can be envisioned.

With these conditions and implications in mind, the need to establish a more independent design practice becomes apparent. When tools shape practice, the follow-up question is: *How can practice shape tools?*

3) Counter Strategies: Practice shapes Tools

Tools are made and shaped by human beings. They don't exist a priori, but instead are subject to specific cultural developments and design choices (Manovich, 2013b, p. 148).

Inspired by the design and research group *OSP* and their motto "The tools we use shape our practices. The practices we have shape our tools." (Open Source Publishing, no date), and in hopes to further explore the idea(l) of a circular interdependency of tools and practice 😊 (De Heij, no date), the following section will propose three strategies for creative makers. These approaches can be considered as possible starting points to slowly break away from engrained ways of working and to move towards a more independent and diverse practice.

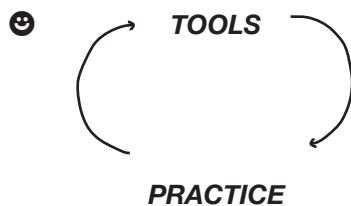

The methods and approaches suggested in the following are strongly connected to practice and based on the notion of *criticality*, which can be described as

“the full awareness of a situation, an awareness of what is at stake, an awareness of the alternatives one is looking for in a forcefield dominated by others. It concerns the perseverance to critically asses what powers in charge are doing (...)” (Korsten, 2021, p. 112)

The combination of *criticality*, *theory* and *practice* goes back to the idea of *critical making*, initially introduced by Matt Ratto as a pedagogical method. He envisions *critical making* as a combination of “two typically disconnected mode of engagement in the world”, namely *critical thinking* and *making*: Abstract and theoretical concepts and ideas are being complemented by a material, embodied and hands-on approach (Ratto and Hockema, 2009, p. 52)

Garnet Hertz builds on Matto's idea of *critical making* and suggests to extend the concept, from technological and computational engagements to other disciplines such as design, and from a purely educational context to a practice outside of academic institutions. According to Hertz, this could help “in *makers* becoming more critically engaged with their medium” and to “reevaluate the assumptions and values being embedded” in their process and outcome. (Hertz, 2016)

Inspired by this wider understanding of *critical making*, the below methods suggest practical ways to critically engage with graphic design tools. While some might be more radical than others, their common goal is to re-adjust practice in order to have a significant impact on tools and how they are being shaped.

3.1) Hacking and Bending

One strategy, that doesn't necessarily abandon all proprietary tools all at once but helps to engage with them more consciously and critically, is to find some inspiration in hacker culture. The term *hacking* usually refers to computational hacking and manipulation of code, but might as well be understood as a stance to operate within a system under given conditions, trying to intervene in this imposed structure and potentially subvert it. In that sense, hacking could be

“... a way to emancipate users of technology from being passive consumers to becoming *critical makers*.” (Groten, 2019, p. 238)

These counteractions can occur on several levels and include different degrees of intensity. For starters, it could simply mean to misuse a tool and to overcome its limitations by bending and repurposing its functionality. 😊 These simple, tiny tweaks and bends already hold potential to critically engage with the tool and to reach a better understanding of the actual limitations and how to overcome them. 😊

😊 For example using Excel to design a poster, purposely producing malfunctions and glitches in InDesign or tampering with the control devices while drawing in Photoshop ...

😊 And not only that! I am sure these tricks could create unexpected and surprising outcome or unseen perspectives that spark future ideas!

One can imagine many more ways to testing and even exceeding the limits of proprietary tools, but all these approaches require a critical understanding and awareness, and some even more so call for technical knowledge and literacy.

“What designers can learn from hackers is that in order to use tools critically, they need to be understood, adapted, and customized.” (Pater, 2021, p. 390)

Criticality, in this sense, requires curiosity to learn and the will to experiment within given limitations in order to stretch the boundaries and explore new (im)possibilities.

3.2) Alternative Tools

A second attempt to gain more independence as a graphic designer can be to change up the toolset by bringing in alternatives.

Most of the digital tools that are in use today were developed by sharing and shaping the code with others – that is of course before they were privatized and capitalized. The point is, that the aspect of collaboration is a well-established concept in programming. Free/Libre and open-source

software (*F/LOSS*) upholds this value of peer production and collective making and shaping. The tools are freely available for usage, and moreover the source code is accessible, inviting users to modify, share and upgrade the tool. This transparency and accessibility creates a community aspect, making sure that practice feeds back into the development of the tool. Even users who are not literate in coding are welcome to report problems and formulate requests, wishes or new ideas to the peer developers.

The clear distinction from proprietary tools becomes apparent in the licenses that are being used to publish those tools: Instead of just putting an uncopyrighted tool in the public domain, they explicitly use *copyleft* licenses to encourage collaboration and distribution.

The flourishing *F/LOSS* scene does offer many alternatives to the industry standards, some of them hardly different to the “original”. But they also offer an intriguing and exciting diversity of tools, not shying away from unusual and idiosyncratic experiments. Marginalized and “outsiders” perspectives can be incorporated without following the economic principles of the market.

Graphic designers often organize their tool ecologies in order to create a seamless and streamlined workflow that connects a variety of tasks and applications. A common argument against the usage of alternative tools is that they cannot be implemented as efficiently and productively as the *standard* tools: Some operations appear to be a bit bumpy, some interfaces are clumsy and the combination of several tasks can be less fluid. Overall, they supposedly require more attention and time.

However, it is not only possible, but sometimes even easier than expected to get used to other tools. Even if the graphic designer feels less comfortable, less confident in this new terrain, it can be beneficial and rewarding to give it a try. It is true that a different environment, particularly one that may be buggy and less elegant, naturally causes friction and uncertainty. Using *F/LOSS* tools, especially in a professional environment, also means to expect a different experience, to accept and even appreciate bugs, glitches and little imperfections. But shouldn't these very moments be cultivated and preserved in any creative process? Alternative tools, with all their idiosyncrasies and characteristics, have the potential to produce and shape more relatable, unusual and interesting outcome.

3.3) Make your own Tools

Making your own tools seems to be the most radical approach to changing your tool ecologies. Even if it sounds challenging, there are several good reasons to give it a try.

For one, there is the chance to create a tool that is situated and embedded in a concrete environment, shaped according to its particular premises and needs. Whilst a *universal* tool is developed with a *one-fits-all* concept, a DIY tool simply doesn't need compromising. Specific peculiarities can be easily addressed, which potentially leads to better results. This can be relevant for undertakings that are considered niche, but even more so it takes into account marginalized perspectives and urgencies.

When creating your own tool, it is not compulsory to

“conform to standard principles of progress, universality and efficiency. There’s no need to claim to be the ‘Next Big Thing’ or to even suggest that anyone, other than the creators of this device, should use it.” (Howell and Pogorzelskiy, no date)

The tool can be unconventional, playful and fun and is freed from necessities that go beyond personal demands. The poetic and vernacular qualities outweigh practicalities and economic interests. A small, intimate gesture may prevail over a grand universal solution.

One more benefit is the detailed knowledge the creators have of their own tool. They understand why it was built and how it works in detail, as well as how to put it to use – including tricks and tweaks to arrive to the best possible outcome. This transparency, combined with the literacy of the creator, allows to instantly adapt the tool according to changing needs and settings. The prospect of flexibility underlines that “‘owning’ our tools is not the same as ‘mastering’ them.” (Snelting, 2008, para. 7)

The ensuing freedom and self-efficiency may encourage graphic designers to experiment with clumsy and crooked DIY tools that help to slow down and unfamiliarize the workflow. With less pressure to design confidently and efficiently, these setups could spark happy accidents and unexpected surprises as well as moments of friction and awkwardness (Snelting, 2008, para. 20), which should be welcome in any creative process. No matter how small or imperfect the gesture, any intervention has the potential to initiate change and push towards a more diverse practice.

Overall, it can be said that both the impact of *tools* on our *practice* as well as the impact of *practice* on our *tools* become apparent in the actual *making*. The suggested strategies of *Hacking and Bending*, *Alternative Tools* and *Make you own Tools* all require active engagement that goes beyond a critical understanding and awareness. In combination with acts of care and maintenance they may help to increase agency over the toolkit. Finding new ways to interrupt engrained habits of graphic designers is a gesture towards a more critical practice. A practice that is not only being shaped by proprietary tools, but instead one that re-evaluates and actively shapes graphic design tools and how they are being used.

These findings and realizations play an integral part in the idea, concept and development of *MODULAR MATTER*. They may be read both as guidelines for the process of *making* the tool as well as a philosophy on how to utilize it later on.

4) MODULAR MATTER: Technical Instructions

This chapter focuses on the technical instructions for *MODULAR MATTER*. It shall give some insights into how the tool works and how it can be put to use. Starting with the overall setup, this section helps to get an overview of the technical infrastructure and workflow. Later on, there will be a detailed description of all individual modules.

4.1) Overall Setup

[Description]

The tool *MODULAR MATTER* is a collection of physical hardware modules that can be arranged and wired in various ways in order to create diverse printed outcome. Inspired by the concept of *Modular Synthesis*, the tool explores unfamiliar ways of creating printed matter beyond traditional *Desktop Publishing*.

[Technical Infrastructure]

MODULAR MATTER works with a number of different module types:

1. Input Module:

The input module *Dynamic Glyph* can be added to the workflow to give text input that will be used by following transform modules. The input module is optional, since some transform modules do not use text input while others have the option to work with a default text.

2. Transform Modules:

A variety of transform modules build the core of the tool and perform unique transformations of text and images. Each module is responsible for a very specific operation and comes with an operation specific, physical interface. Buttons, knobs and switches on the hardware modules can be adjusted to define the parameters for each transformation.

By choosing which modules are being used and by arranging and connecting them in a specific order, the transform modules create a unique workflow towards printed outcome.

3. Output Module:

The output module *Emergent Matter* generates the final output of the whole workflow and can be connected to any transform module. Using the data that is generated by the sequence of previous modules, it is creating a postscript file which is sent to the printer or the preview screen.

[Setup]

The printed outcome of *MODULAR MATTER* is in large part defined by the variable setup of the hardware modules. The patch example demonstrates how the different hardware modules of *MODULAR MATTER* can be arranged in order to create a workflow. The purple patch cables connect the output socket of one module to the input socket of another module.

In this example, the input module *Dynamic Glyph*, the transform module *Whoosh* and the output module *Emergent Matter* are operating in sequential order: The output of *Dynamic Glyph* is used as the input for *Whoosh*, and so forth.

While *Emergent Matter* always marks the end of the whole operation, the input and transform modules are optional and can be rearranged according to the needs of the user. Changing the order or excluding a module from the workflow will create different outcome.

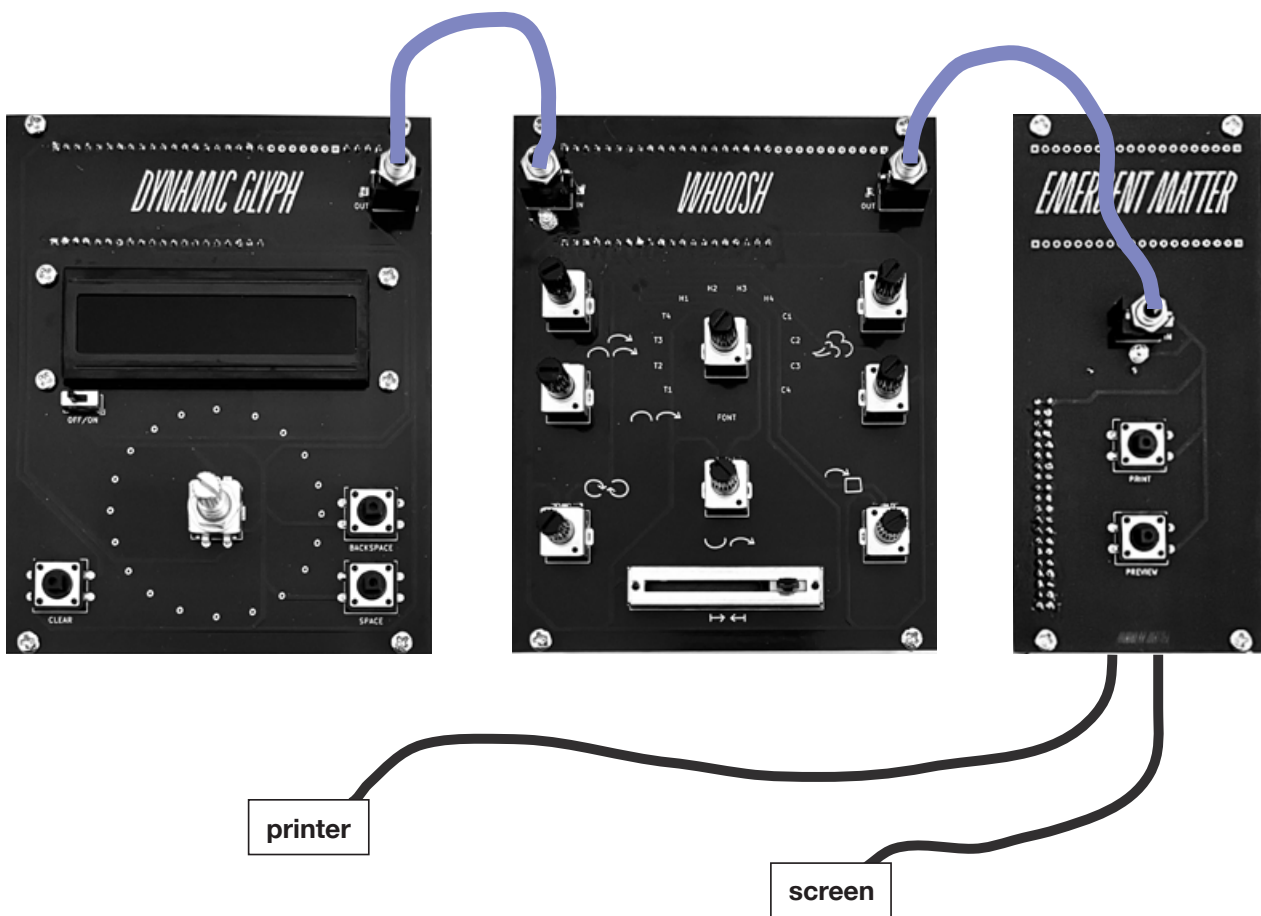

All input and transform modules work with a microcontroller that runs the specific operation in the form of a C++ sketch. The output modules work with a Raspberry Pi that runs a modular python script. All code documentation is available here:

https://git.xpub.nl/ohjian/MODULAR_MATTER/

4.2) Single Modules

This section introduces the single modules of the tool. A detailed description is accompanied by practical instructions and use cases. Some technical background information is provided to explain the operation and how the module may be integrated into a workflow.



DYNAMIC GLYPH

[Title]

Dynamic Glyph

[Module Type]

Input Module

[Description]

The input module *Dynamic Glyph* can be used to give text input that will be used by the following transform modules.

As a default the module uses a small selection of glyphs, including the letters of the Latin alphabet and a few special characters.

[Instructions]

To integrate the *Dynamic Glyph* module into a workflow, the output socket should be connected to other transform modules. With the LCD display turned on, the big knob can be rotated to select a character from the glyph set and pressed to add it to the text.

[Settings]

The table lists all adjustable components of the *Dynamic Glyph* module, as well as information about the parameters they affect.

<i>parameter</i>	<i>component</i>	<i>value range</i>	<i>description</i>
output	patch cable, socket	connected / not connected	connects the output socket of this module to the input socket of the next module
LCD power	small slide switch	on / off	turns the LCD display on or off
glyph select	rotary encoder wheel	A-Z, a-z, 0-9, selected special characters	defines the next character that should be added to the text
glyph submit	rotary encoder push button	button pressed / not pressed	adds the selected character to the text
clear	push button	button pressed / not pressed	clears the text
backspace	push button	button pressed / not pressed	deletes the last character in the text
space	push button	button pressed / not pressed	adds a space to the text

[Tips & Tricks]

- [1] The text input can be used by the transform modules *Friction Label* and *Whoosh!*
- [2] Keep the text short!
- [3] Experiment with capital and lowercase letters as well as special characters!
- [4] Add spaces to create gaps in the text!

[Technical Data]

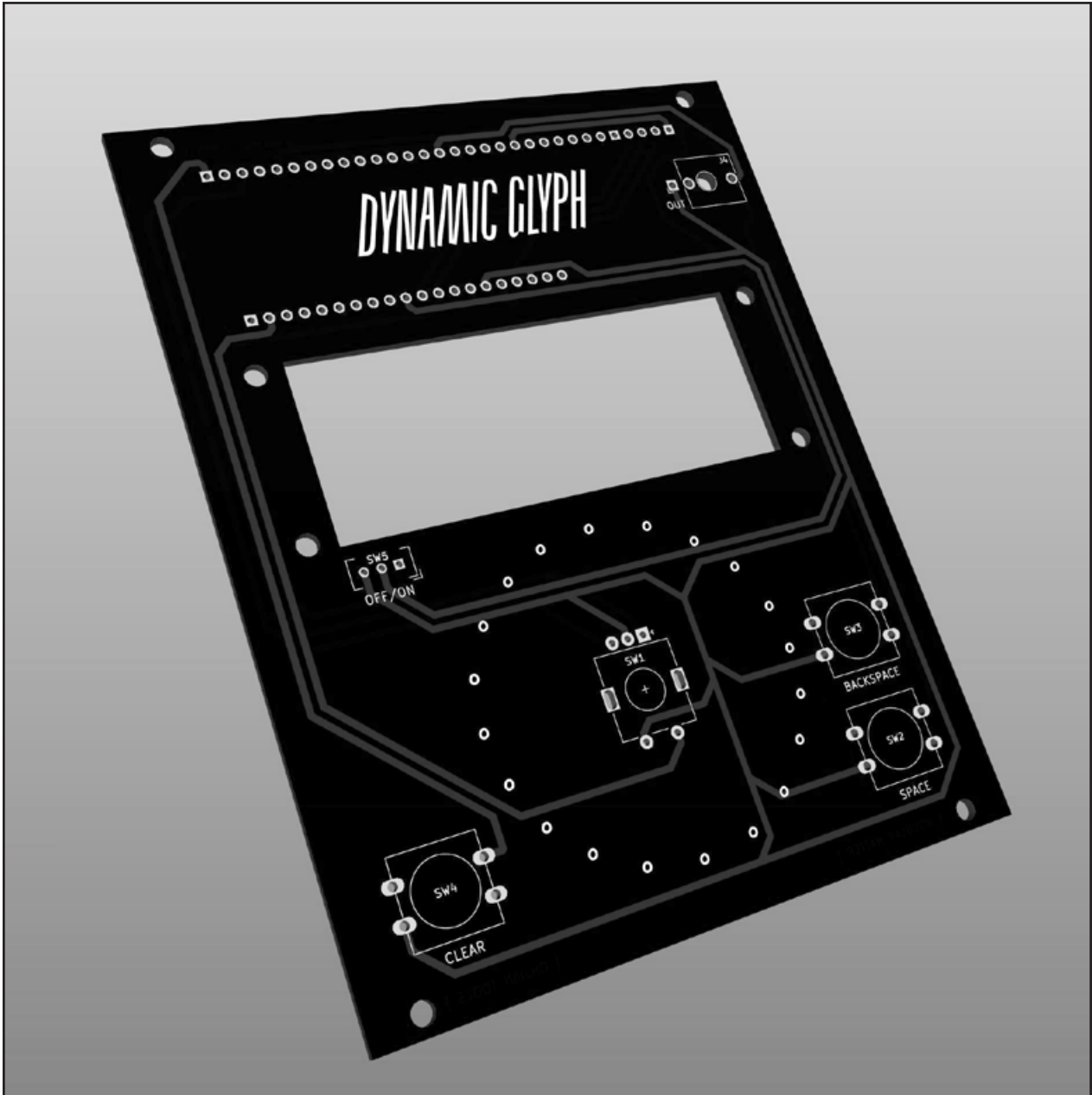

[Setup]

- 1 audio jack
- 1 rotary encoder
- 3 push buttons
- 1 small slide switch
- 1 LED, 3 mm
- 1 resistor, 1k
- 2 pin headers, 1 x 20 sockets;

add: 1 LilyGO TTGO T8 ESP32-S2 + power supply; 1 DFRobot I2C 16x2 LCD; audio patch cables; 8 M3 bolts + nuts

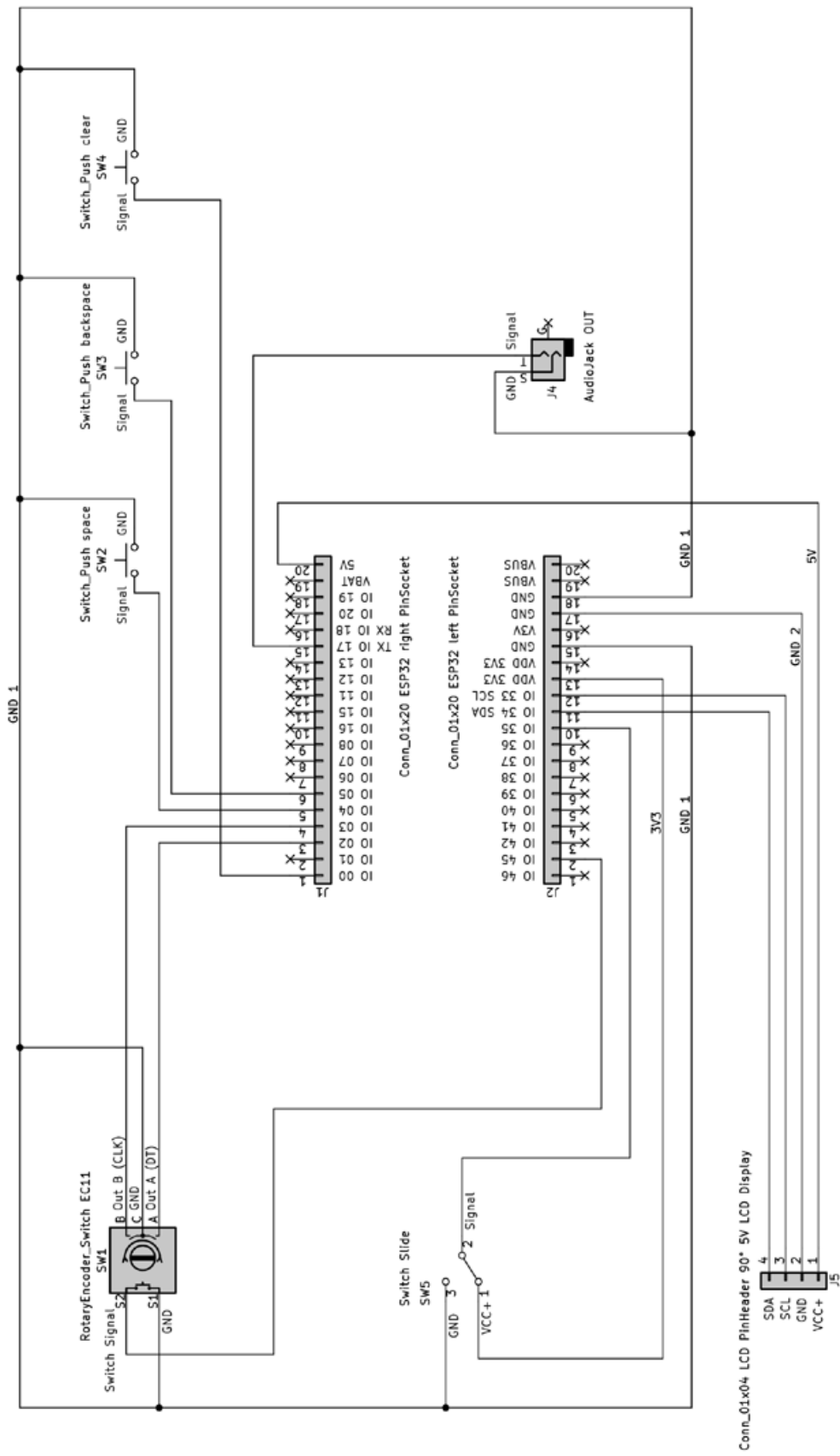

ESP32

1. read incoming values from: 1 rotary encoder, 3 push buttons, 1 slide switch
2. send serial data (TX) via 1 audio socket
3. send values to 5V LCD Display. LED

ohjjan tools

Sheet: /
 File: dynamic_glyph.kicad_sch

Title: MODULAR MATTER - DYNAMIC GLYPH

Size: A4 Date: 2023-05-24 Rev: 1
 KiCad E.D.A. eeschema (6.0.10-0) Id: 1/1

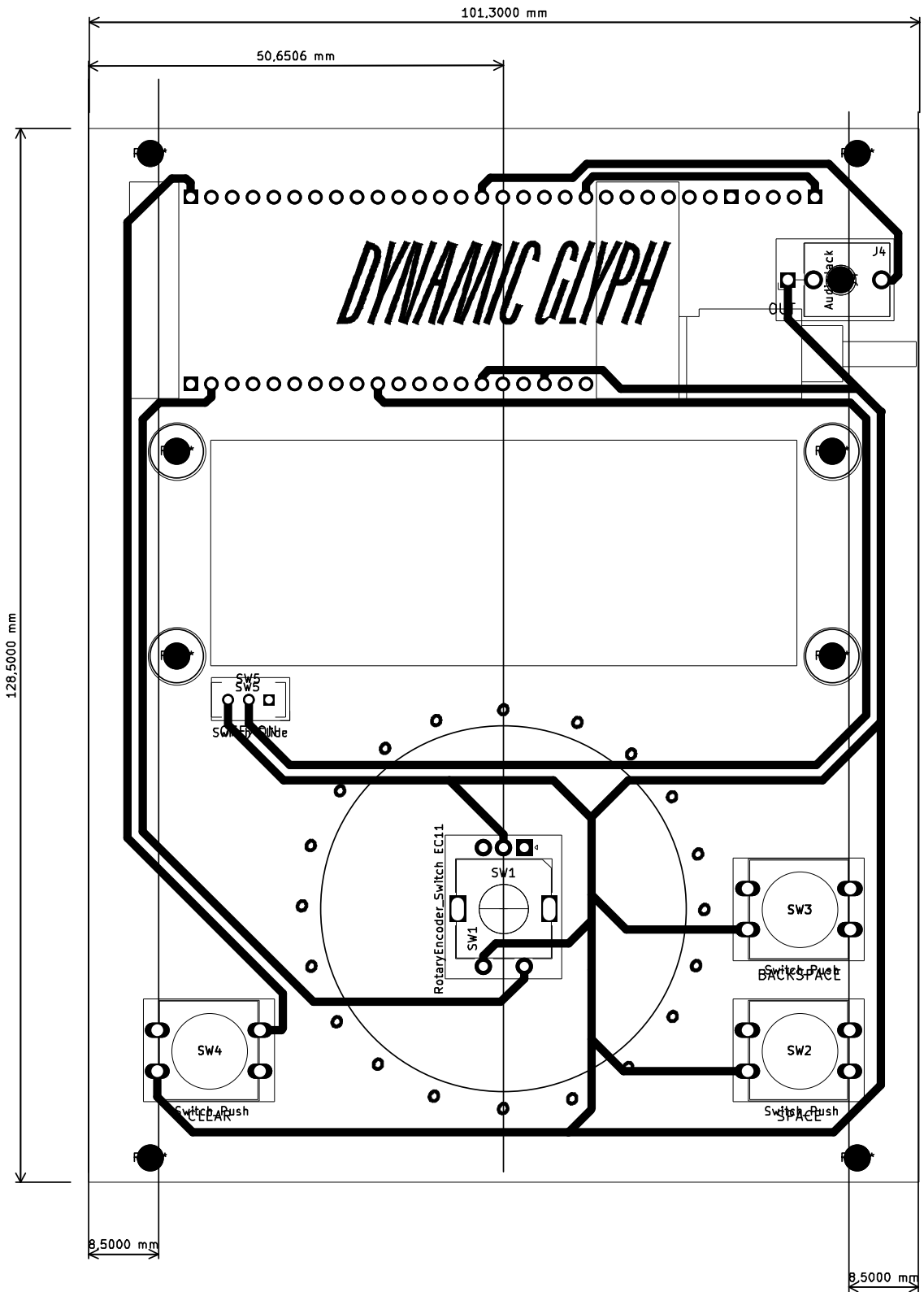

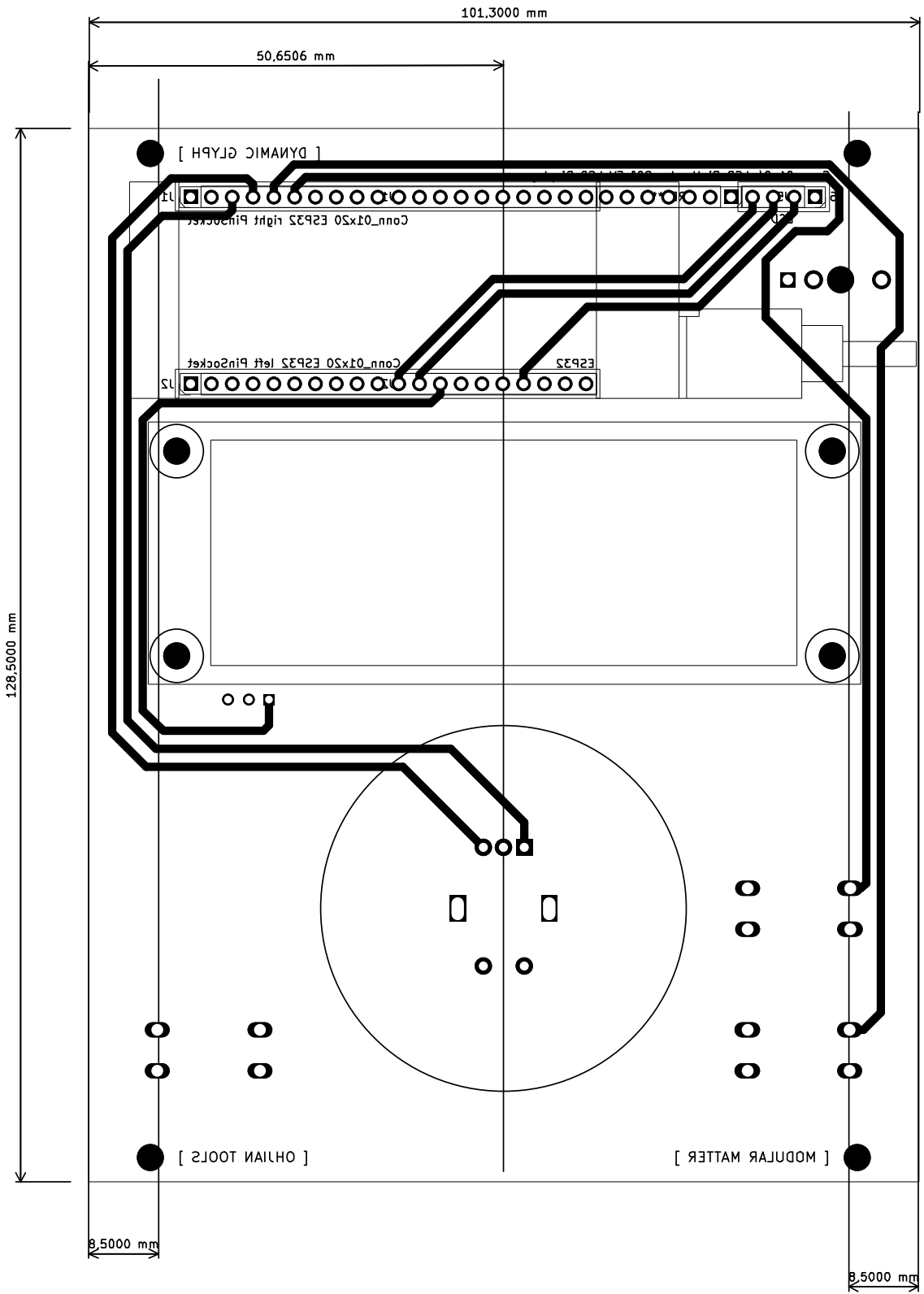

FRICTION LABEL

[Title]

Friction Label

[Module Type]

Transform Module

[Description]

The transform module *Friction Label* can be used to add a new typo-graphic layer to the print layout. Usually, labels or stickers come in the form of short text inside a decorative shape and are used for branding purposes. The sleek design is supposed to carry the identity or additional information about an item.

The *Friction Label* module uses this typical format as inspiration, yet the parameters for the styling range in the extremes only and cause moments of failure and distortion. This effect encourages makers to test the margins and limitations of labels and to explore the cracks on the surface.

The main factors that shape the new label are the text input, the font choice and the outline of the text. Additional parameters such as font-size, position, rotation and gray tones can be used to refine the styling.

The outcome is a text in an unexpected, bulky and sometimes spiky shape. This sticker-like format can be added to any layout as a finishing touch.

[Instructions]

To integrate the *Friction Label* module into a workflow, the input and output sockets should be connected to other transform modules. In order to use custom text instead of the default text, add the input module *Dynamic Glyph* as a first module to the workflow. In case *Friction Label* is the first module in the workflow, the input socket does not need to be connected. In case it is the last transform module in the workflow, the output socket should be connected to the output module *Emergent Matter*.

[Settings]

The table lists all adjustable components of the *Friction Label* module, as well as information about the parameters they affect.

<i>parameter</i>	<i>component</i>	<i>value range</i>	<i>description</i>
input	patch cable, socket	connected / not connected	connects the input socket of this module to the output socket of the previous module
output	patch cable, socket	connected / not connected	connects the output socket of this module to the input socket of the next module
font	rotary potentiometer	Times (Roman, Italic, Bold, Bold Italic); Helvetica (Regular, Oblique, Bold, Bold Oblique); Courier (Regular, Oblique, Bold, Bold Oblique)	defines the font
outline	rotary potentiometer	20 px to 120 px	defines the stroke width of the text outline
font-size	rotary potentiometer	1 px to 200 px	defines the font-size
x position	slide potentiometer	0 px to 450 px	defines the x position of the text, starting in the lower left corner;
y position	slide potentiometer	0 px to 700 px	defines the y position of the text, starting in the lower left corner;
rotation	rotary potentiometer	0 to 20 degree	defines the rotation of the text
gray tone text	slide potentiometer	0,0 to 1,0 0,0 = black 1,0 = white	defines the gray tone of the text
gray tone outline	slide potentiometer	0,0 to 0,9 0,0 = black 0,9 = light gray	defines the gray tone of the outline

[Tips & Tricks]

- [1] Best combined with the input module *Dynamic Glyph!* Otherwise it uses a default text!
- [2] If you want the sticker to be the top layer of your layout, use *Friction Label* as the last module before printing!
- [3] Extreme values in position, rotation and font-size can make the label disappear from the canvas!
- [4] Experiment with extreme values for font-size in relation to outline!
- [5] Experiment with the contrast of the two gray tones!
- [6] When using a big font-size, *Friction Label* can create an interesting shape for the background as well!

[Technical Data]

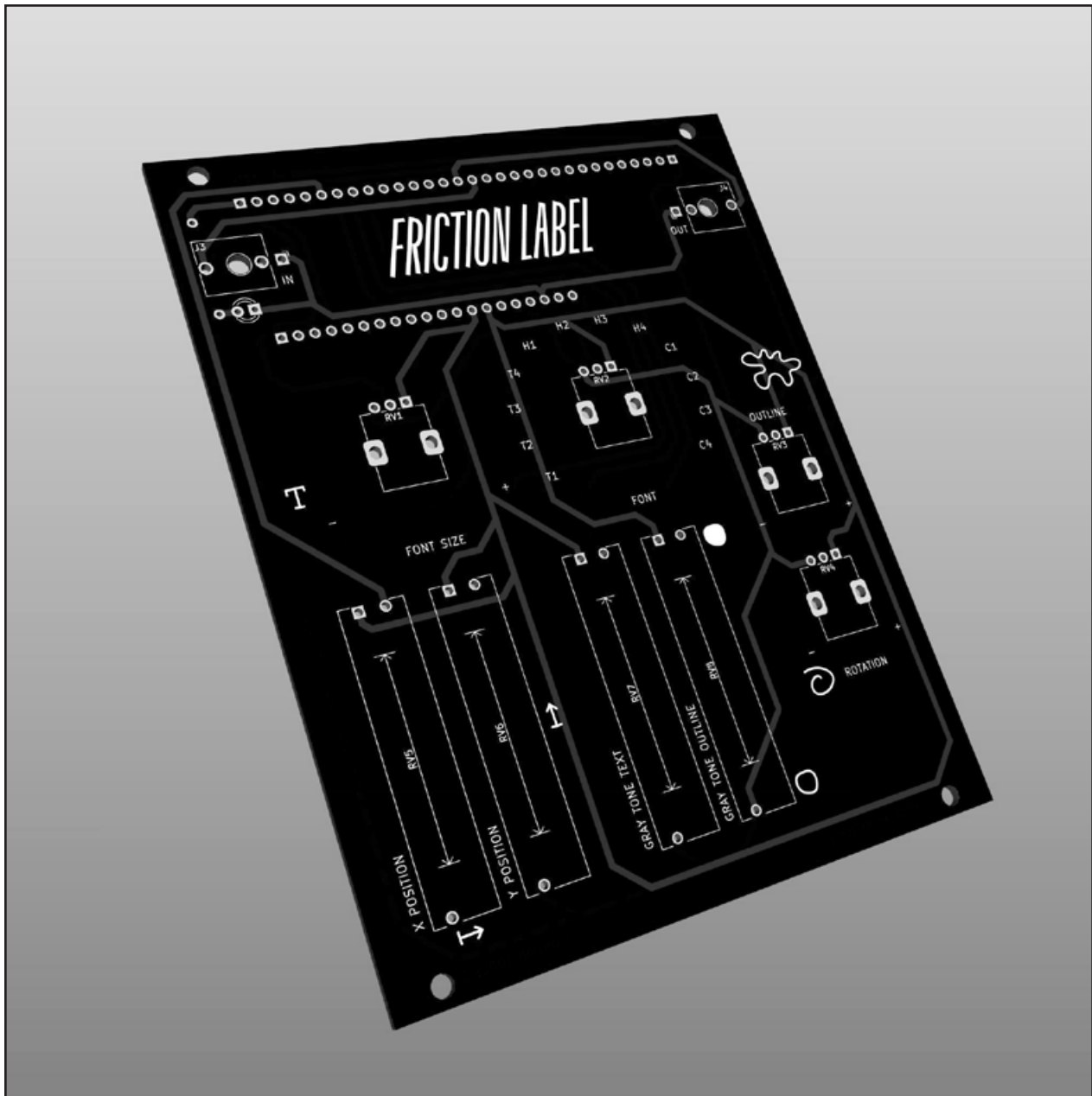

[Setup]

- 2 audio jacks
- 4 rotary potentiometers, 10k
- 4 slide potentiometers, 10k
- 1 LED, 3 mm
- 1 resistor, 1k
- 2 pin headers, 1 x 20 sockets

add: 1 LilyGO TTGO T8 ESP32-S2 + power supply; audio patch cables; 4 M3 bolts + nuts

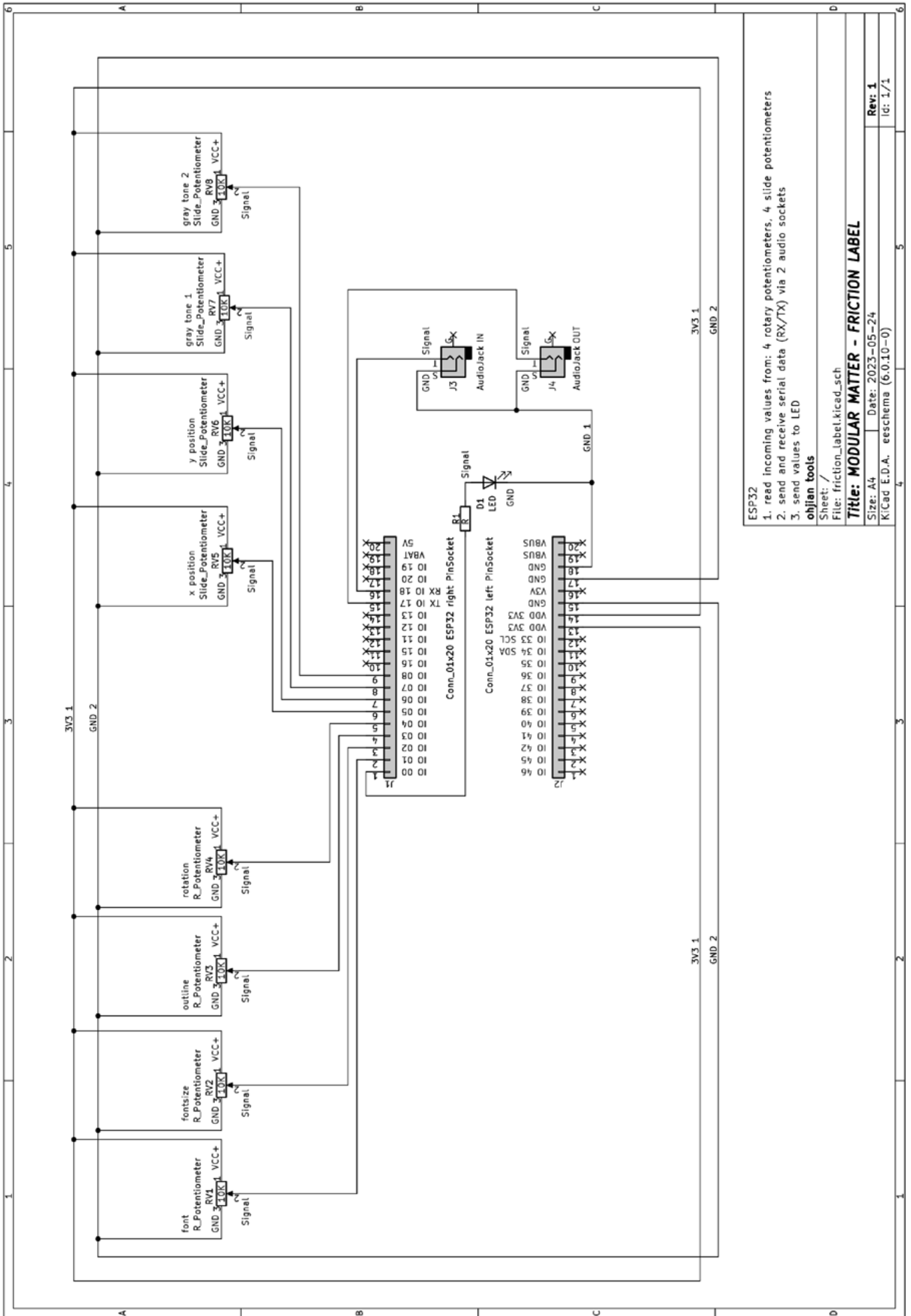

ESP32

1. read incoming values from: 4 rotary potentiometers, 4 slide potentiometers
2. send and receive serial data (RX/TX) via 2 audio sockets
3. send values to LED

objian tools

Sheet: /
File: friction_label.kicad_sch

Title: MODULAR MATTER - FRICTION LABEL

Size: A4 Date: 2023-05-24
KiCad E.D.A. eeschema (6.0.10-0)

Rev: 1
Id: 1/1

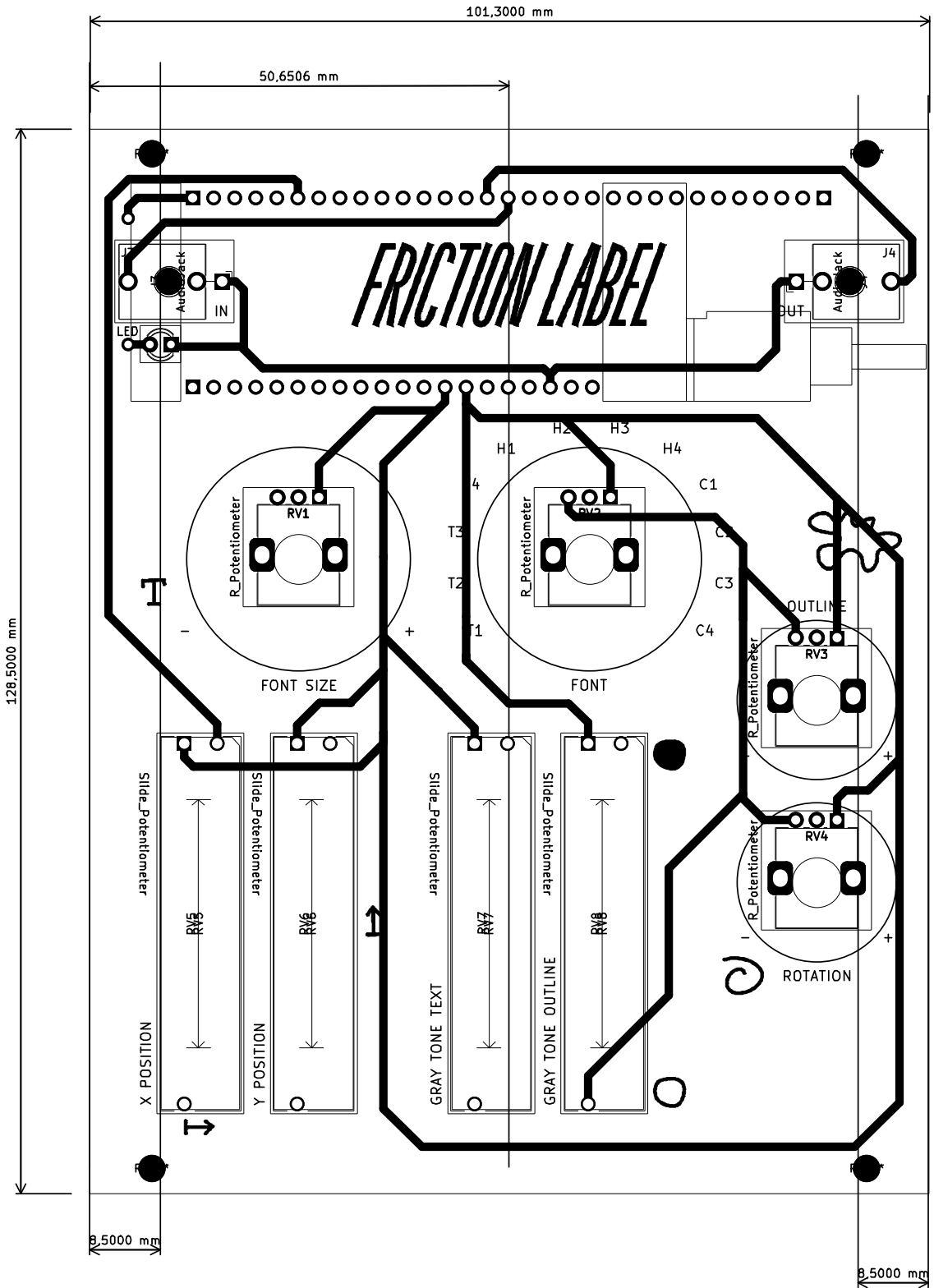

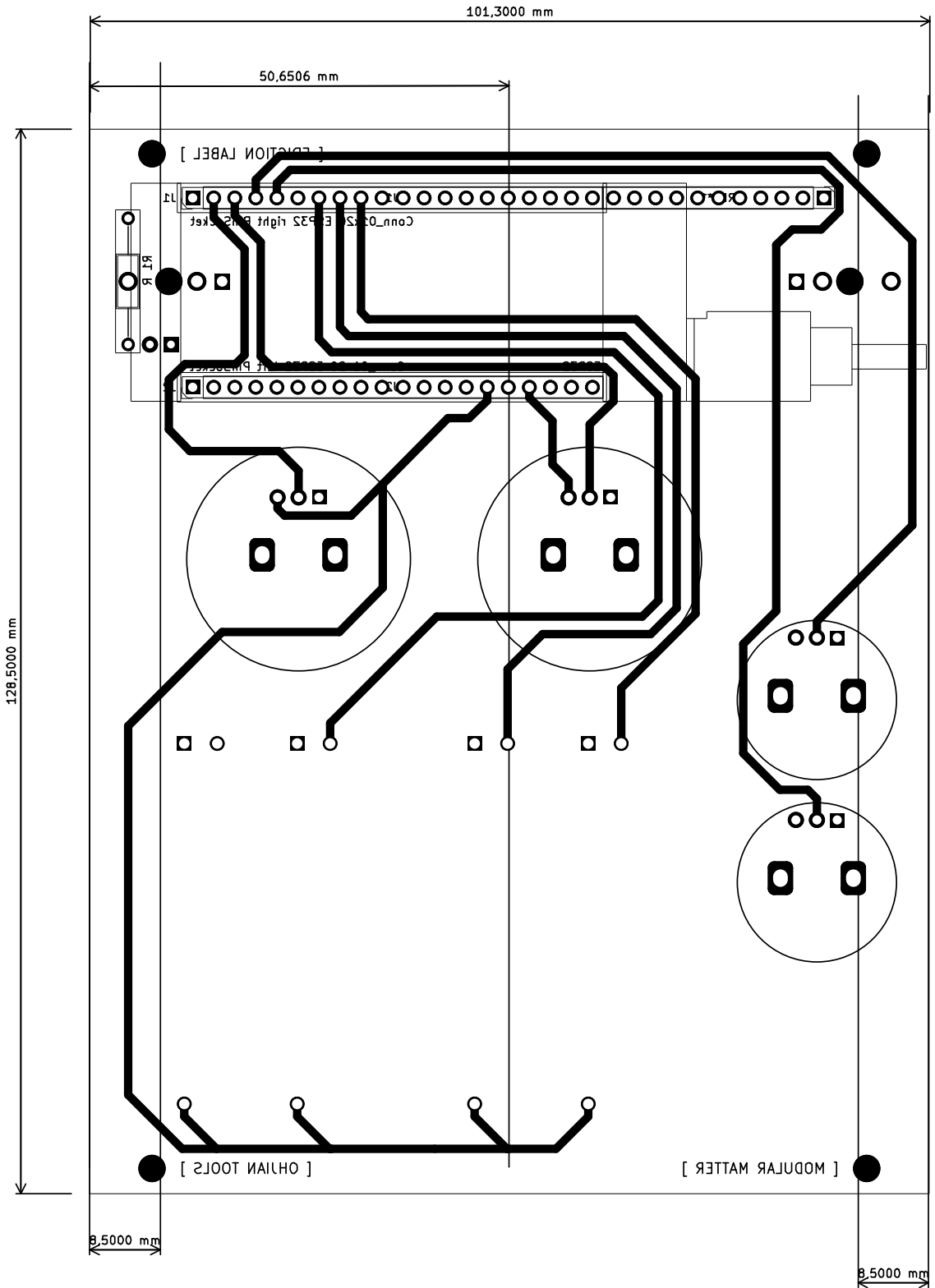

FUTURE RELICS

[Title]

Future Relics

[Module Type]

Transform Module

[Description]

The transform module *Future Relics* can be used to add a new graphical layer to the print layout. The shapes and forms range from bubble to spike to fraction to square and can be used to create an interesting composition on the page. Additional parameters such as position, rotation and gray tone can be used to refine the styling. The outcome is an unexpected, bulky and sometimes spiky shape.

[Instructions]

To integrate the *Future Relics* module into a workflow, the input and output sockets should be connected to other transform modules. In case *Future Relics* is the first module in the workflow, the input socket does not need to be connected. In case it is the last transform module in the workflow, the output socket should be connected to the output module *Emergent Matter*.

[Settings]

The table lists all adjustable components of the *Future Relics* module, as well as information about the parameters they affect.

<i>parameter</i>	<i>component</i>	<i>value range</i>	<i>description</i>
input	patch cable, socket	connected / not connected	connects the input socket of this module to the output socket of the previous module
output	patch cable, socket	connected / not connected	connects the output socket of this module to the input socket of the next module
shape	rotary potentiometer	bubble, spike, fraction, square	defines the shape of the graphical object
x position	slide potentiometer	0 px to 450 px	defines the x position of the text, starting in the lower left corner;
y position	slide potentiometer	0 px to 700 px	defines the y position of the text, starting in the lower left corner;
rotation	rotary potentiometer	0 to 20 degree	defines the rotation of the text
gray tone	slide potentiometer	0,0 to 0,9 0,0 = black 0,9 = light gray;	defines the gray tone of graphical object

[Tips & Tricks]

- [1] This module uses a random function, so the outcome might be a surprise!
- [2] Extreme values in position and rotation can make the label disappear from the canvas!

[Technical Data]

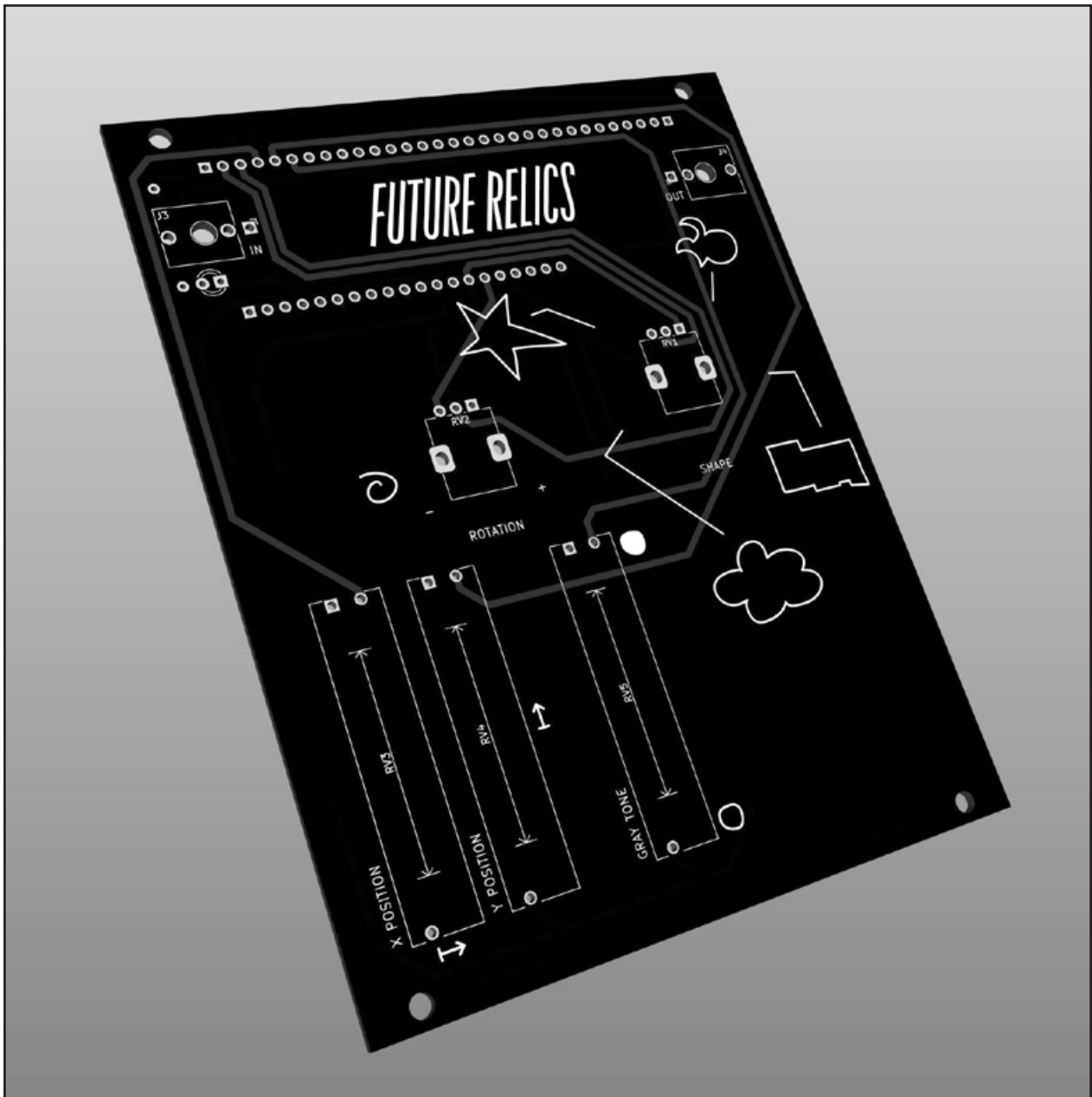

[Setup]

- 2 audio jacks
- 2 rotary potentiometers, 10k
- 3 slide potentiometers, 10k
- 1 LED, 3 mm
- 1 resistor, 1k
- 2 pin headers, 1 x 20 sockets

add: 1 LilyGO TTGO T8 ESP32-S2 + power supply; audio patch cables; 4 M3 bolts + nuts

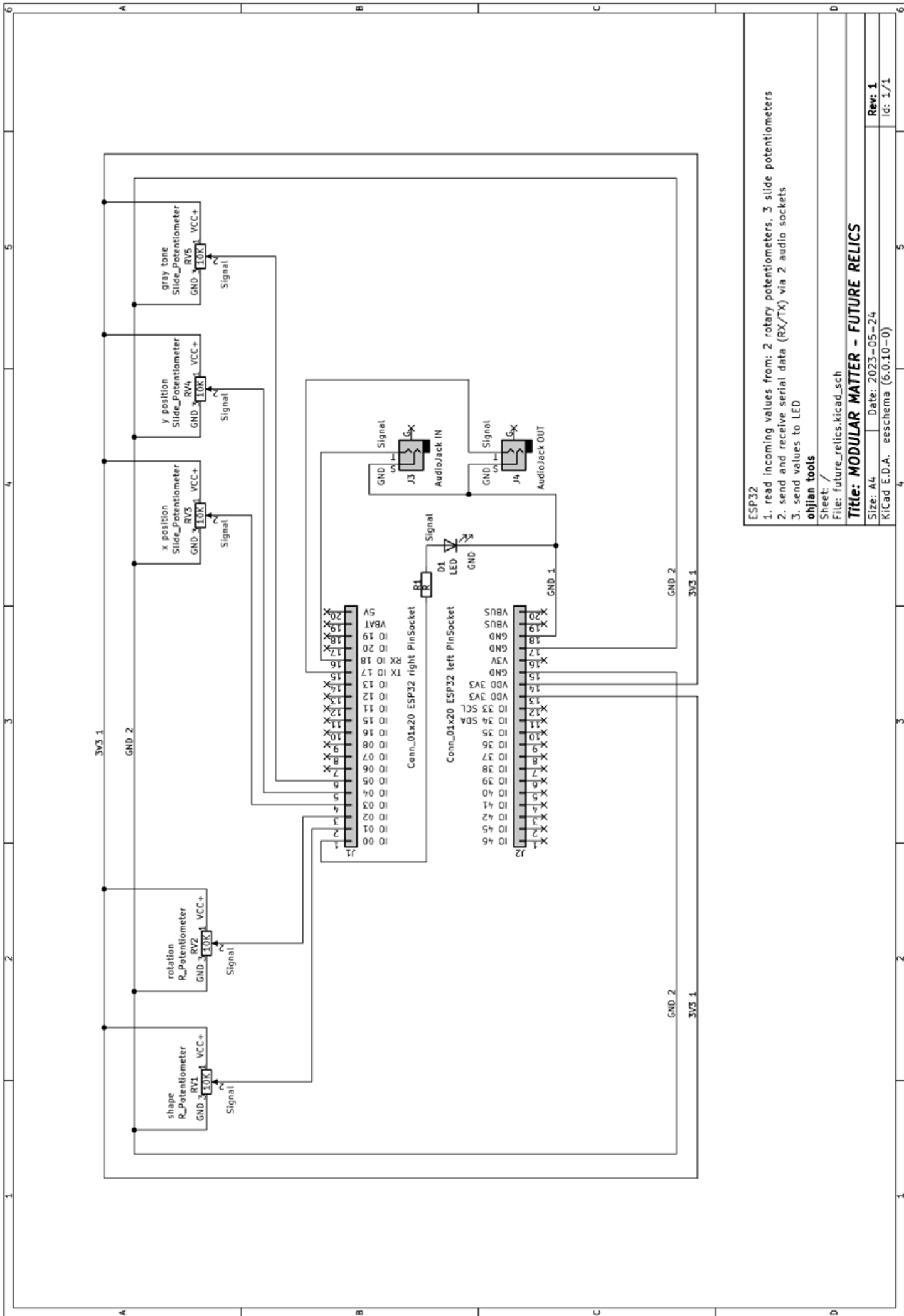

ESP32

1. read incoming values from: 2 rotary potentiometers, 3 slide potentiometers
2. send and receive serial data (RX/TX) via 2 audio sockets
3. send values to LED

ohjjan tools

Sheet: /
 File: future_relics.kicad_sch

Title: MODULAR MATTER - FUTURE RELICS

Size: A4 Date: 2023-05-24
 KiCad E.D.A. eeschema (6.0.10-0)

Rev: 1
 Id: 1/1

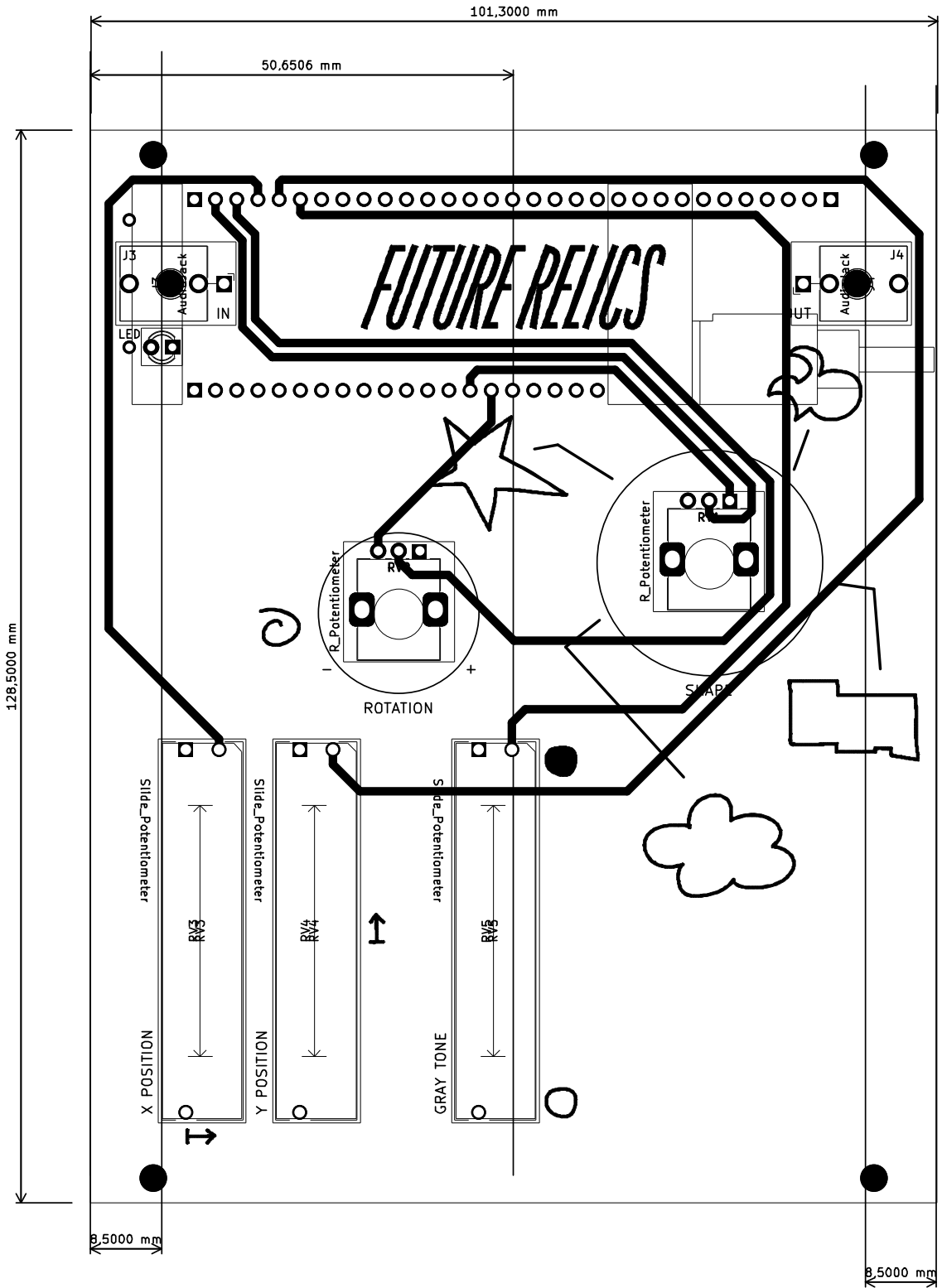

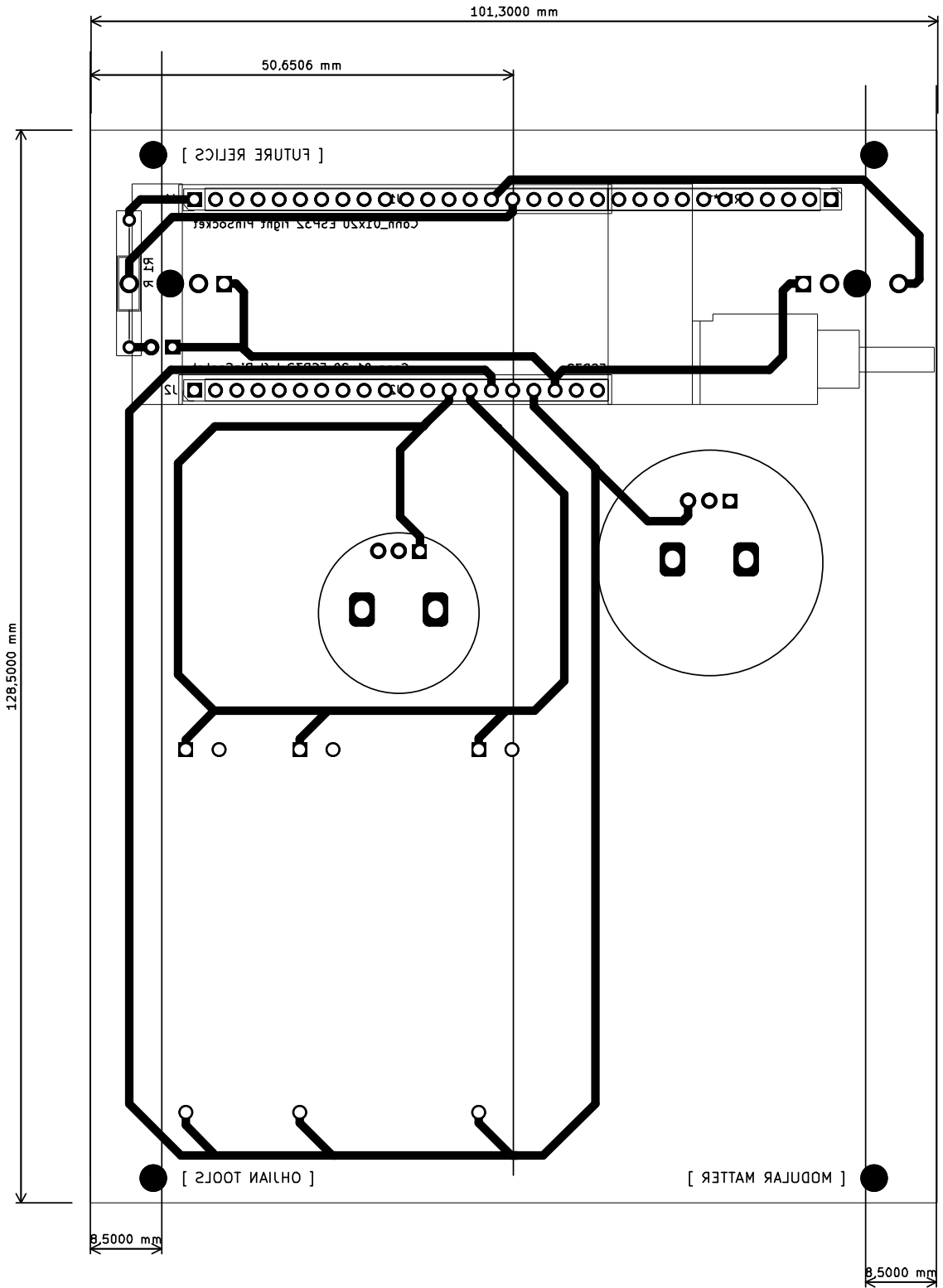

WEAVER

[Title]

Weaver

[Module Type]

Transform Module

[Description]

The transform module *Weaver* can be used to add a typo-graphic pattern to the print layout. The main factors that shape the final patchwork are the rotary knobs that define all positions of four basic patterns. Additional parameters can be used to add repetition factors that create a rhythm for the patterns. Ultimately, patch cables are being used to pair and weave the basic patterns in order to create a final patchwork.

[Instructions]

To integrate the *Weaver* module into a workflow, the input and output sockets should be connected to other transform modules. In case *Weaver* is the first module in the workflow, the input socket does not need to be connected. In case it is the last transform module in the workflow, the output socket should be connected to the output module *Emergent Matter*.

[Settings]

The table lists all adjustable components of the *Weaver* module, as well as information about the parameters they affect.

<i>parameter</i>	<i>component</i>	<i>value range</i>	<i>description</i>
input	patch cable, socket	connected / not connected	connects the input socket of this module to the output socket of the previous module
output	patch cable, socket	connected / not connected	connects the output socket of this module to the input socket of the next module
pattern 1	3 rotary potentiometers	A-D	define the three positions of pattern1
pattern 2	3 rotary potentiometers	A-D	define the three positions of pattern2
pattern 3	3 rotary potentiometers	A-D	define the three positions of pattern3
pattern 4	3 rotary potentiometers	A-D	define the three positions of pattern4
pattern	rotary potentiometer	1-4	defines the repetition factor within each pattern
patch	rotary potentiometer	1-4	defines the repetition factor within each patch
patchwork	rotary potentiometer	1-15	defines the repetition factor of the whole patchwork
pairing	2 patch cables, 4 sockets	paired / not paired	defines the pairing of pattern 1-4

[Tips & Tricks]

- [1] Use the rotary knobs in the grid to create four interesting basic patterns!
- [2] Play with the repetition factors!
- [3] Experiment with the patch cables to test different pairings of the basic patterns!

[Technical Data]

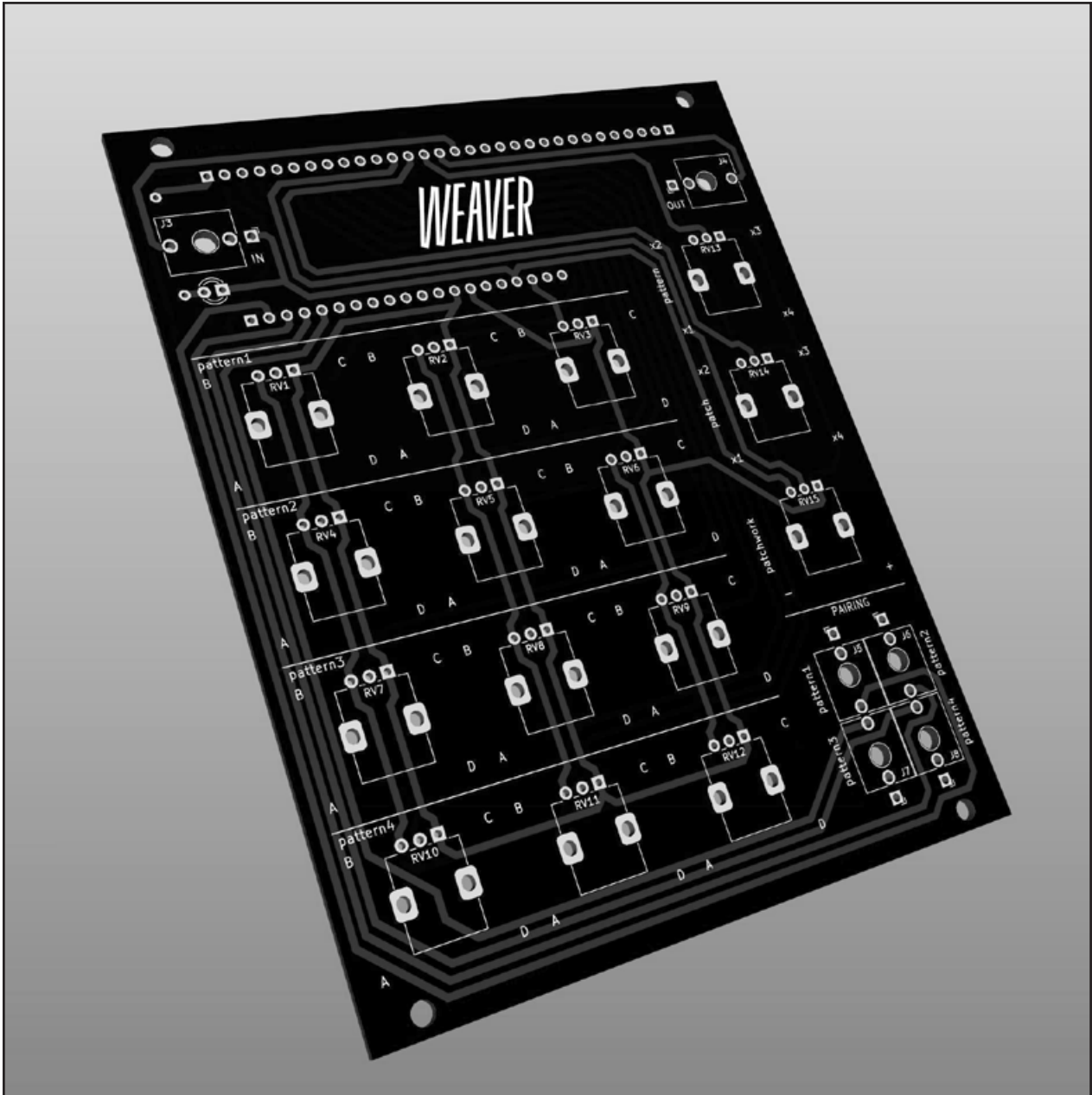

[Setup]

- 6 audio jacks
- 15 rotary potentiometers, 10k
- 1 LED, 3 mm
- 1 resistor, 1k
- 2 pin headers, 1 x 20 sockets

add: 1 LilyGO TTGO T8 ESP32-S2 + power supply; audio patch cables; 4 M3 bolts + nuts

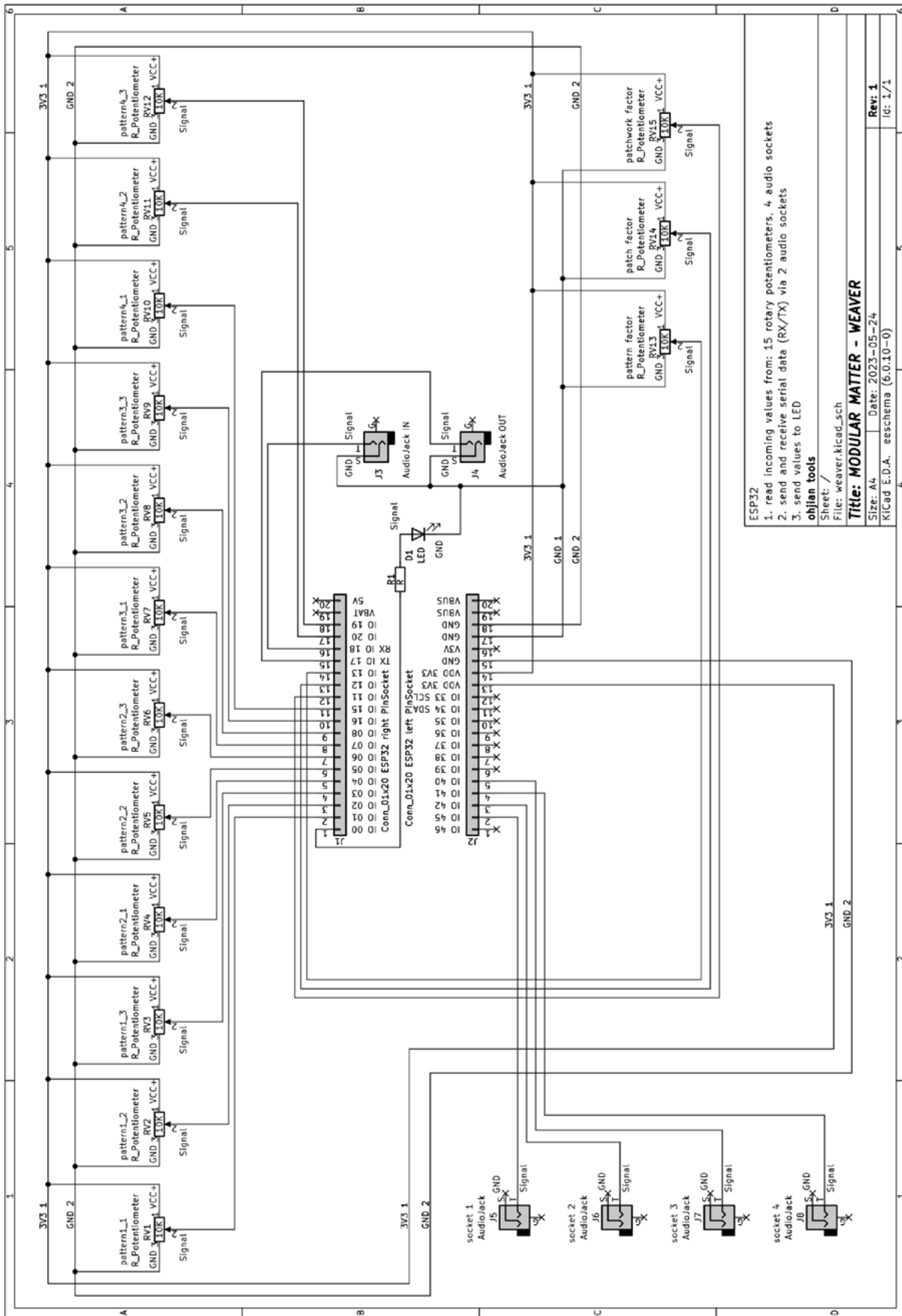

ESP32

1. read incoming values from: 15 rotary potentiometers, 4 audio sockets
2. send and receive serial data (RX/TX) via 2 audio sockets
3. send values to LED

ohjjan tools

Sheet: /
File: weaver.kicad_sch

Title: MODULAR MATTER - WEAVER

Size: A4 Date: 2023-05-24
KiCad E.D.A. eeschema (6.0.10-0)

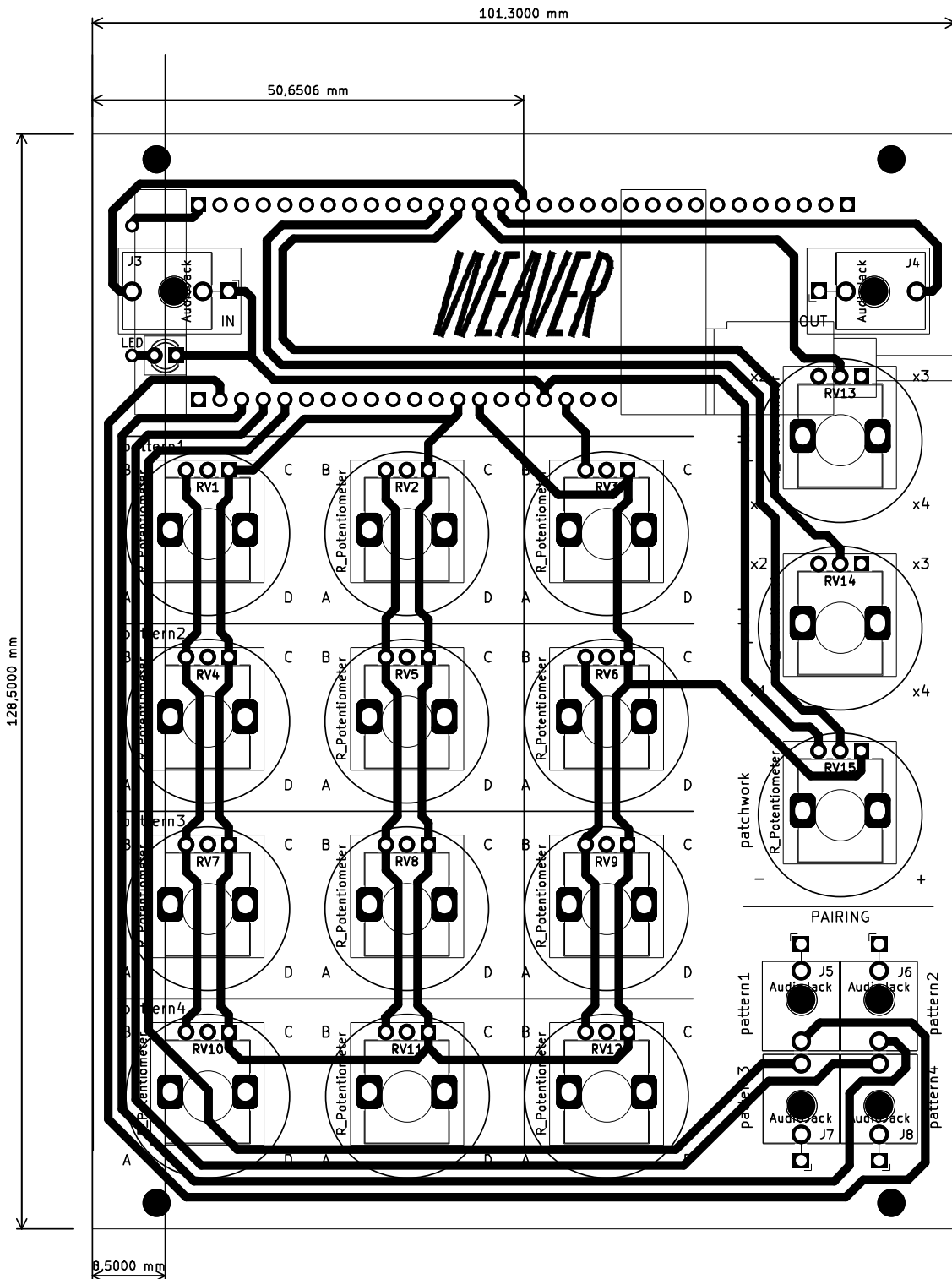

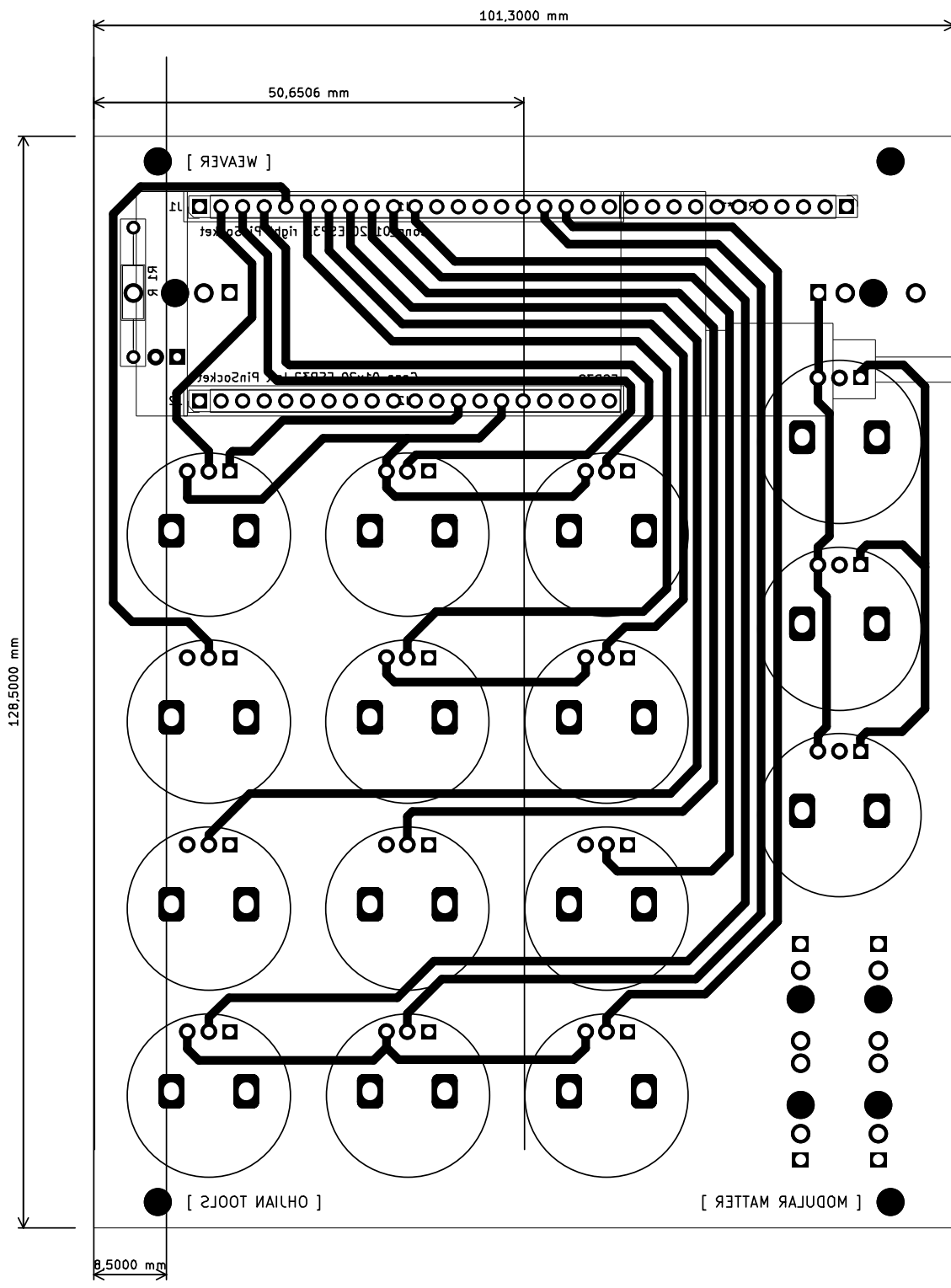

WHOOSH

[Title]

Whoosh

[Module Type]

Transform Module

The transform module *Whoosh* can be used to add a new typographic layer to the print layout. The operation is inspired by a wind or breeze that blows into a small body of text, playing with the words and carrying them to new places. The main factor that shapes the outcome is the text input. Additional parameters regulate the strength, speed, acceleration and vortex of air flow. The outcome is a poetic and spatial text layout that plays with repetition and white space.

[Instructions]

To integrate the *Whoosh* module into a workflow, the input and output sockets should be connected to other transform modules. In order to use custom text instead of the default text, add the input module *Dynamic Glyph* as a first module to the workflow. In case *Whoosh* is the first module in the workflow, the input socket does not need to be connected. In case it is the last transform module in the workflow, the output socket should be connected to the output module *Emergent Matter*.

[Settings]

The table lists all adjustable components of the *Whoosh* module, as well as information about the parameters they affect.

<i>parameter</i>	<i>component</i>	<i>value range</i>	<i>description</i>
input	patch cable, socket	connected / not connected	connects the input socket of this module to the output socket of the previous module
output	patch cable, socket	connected / not connected	connects the output socket of this module to the input socket of the next module
font	potentiometer	Times (Roman, Italic, Bold, Bold Italic); Helvetica (Regular, Oblique, Bold, Bold Oblique); Courier (Regular, Oblique, Bold, Bold Oblique)	defines the font
breezes and winds	7 rotary potentiometers	rising and fading levels of intensity	defines strength, speed, acceleration and vortex of air flow
line width	slide potentiometer	short to long	

[Tips & Tricks]

- [1] Best combined with the input module *Dynamic Glyph!* Otherwise it uses a default text!
- [2] Experiment with different text input!
- [3] Explore all parameters and take the outcome as a surprise!

[Technical Data]

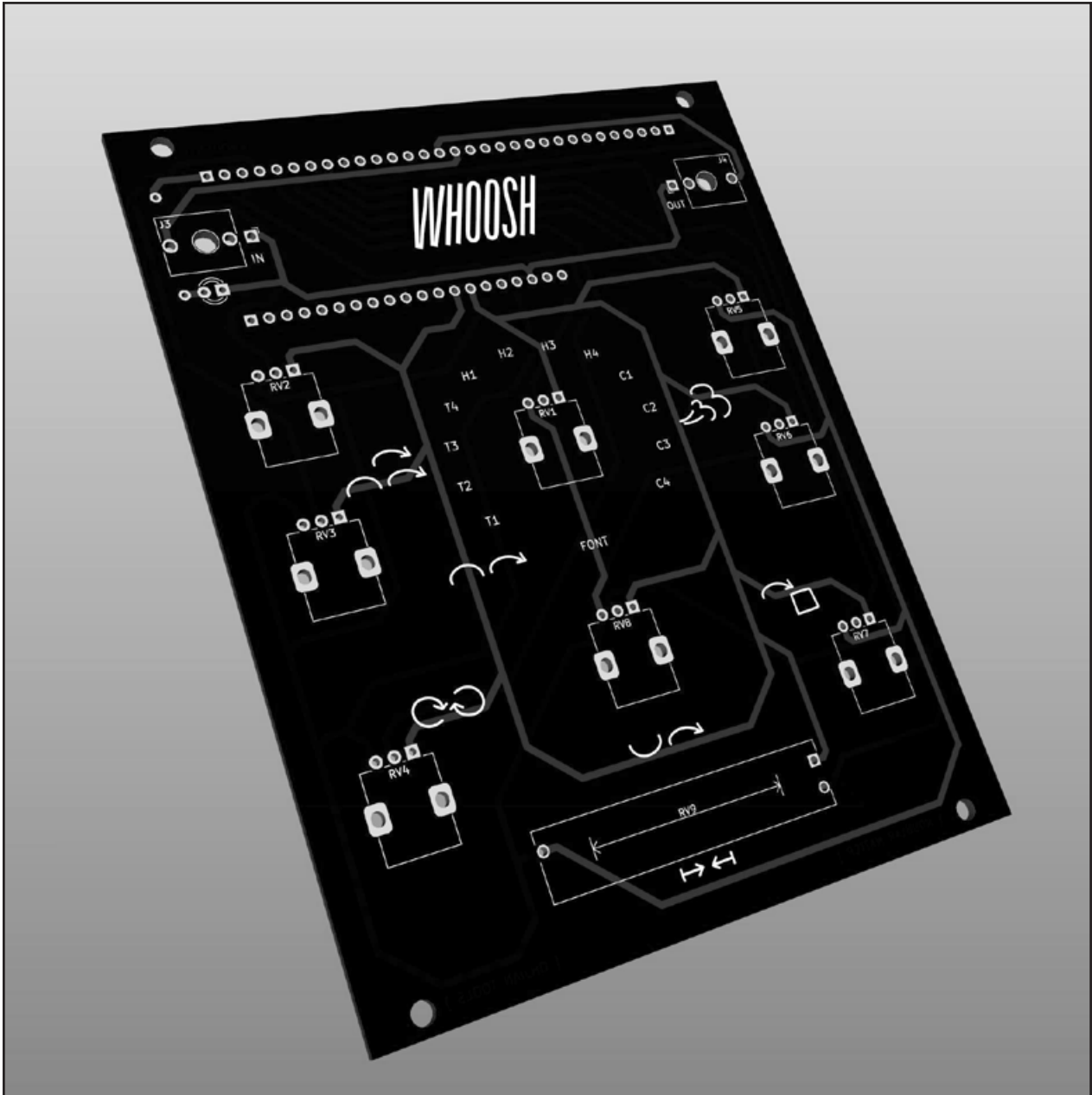

[Setup]

- 2 audio jacks
- 8 rotary potentiometers, 10k
- 1 slide potentiometer, 10k
- 1 LED, 3 mm
- 1 resistor, 1k
- 2 pin headers, 1 x 20 sockets

add: 1 LilyGO TTGO T8 ESP32-S2 + power supply; audio patch cables; 4 M3 bolts + nuts

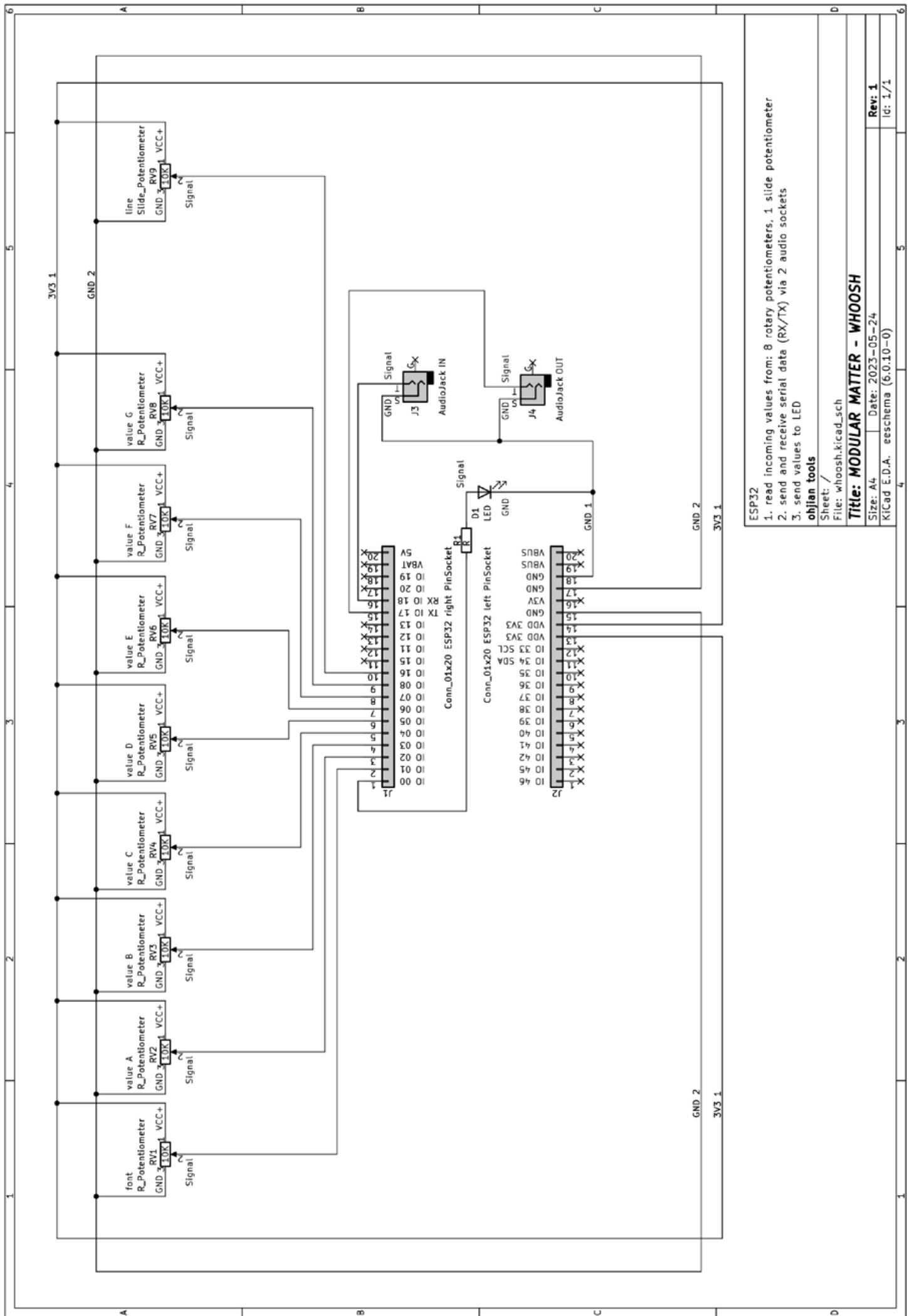

ESP32

1. read incoming values from: 8 rotary potentiometers, 1 slide potentiometer
2. send and receive serial data (RX/TX) via 2 audio sockets
3. send values to LED

ohjjan tools

Sheet: /
 File: whoosh.kicad.sch

Title: MODULAR MATTER - WHOOSH

Size: A4 Date: 2023-05-24
 KiCad E.D.A. eeschema (6.0.10-0)

Rev: 1
 Id: 1/1

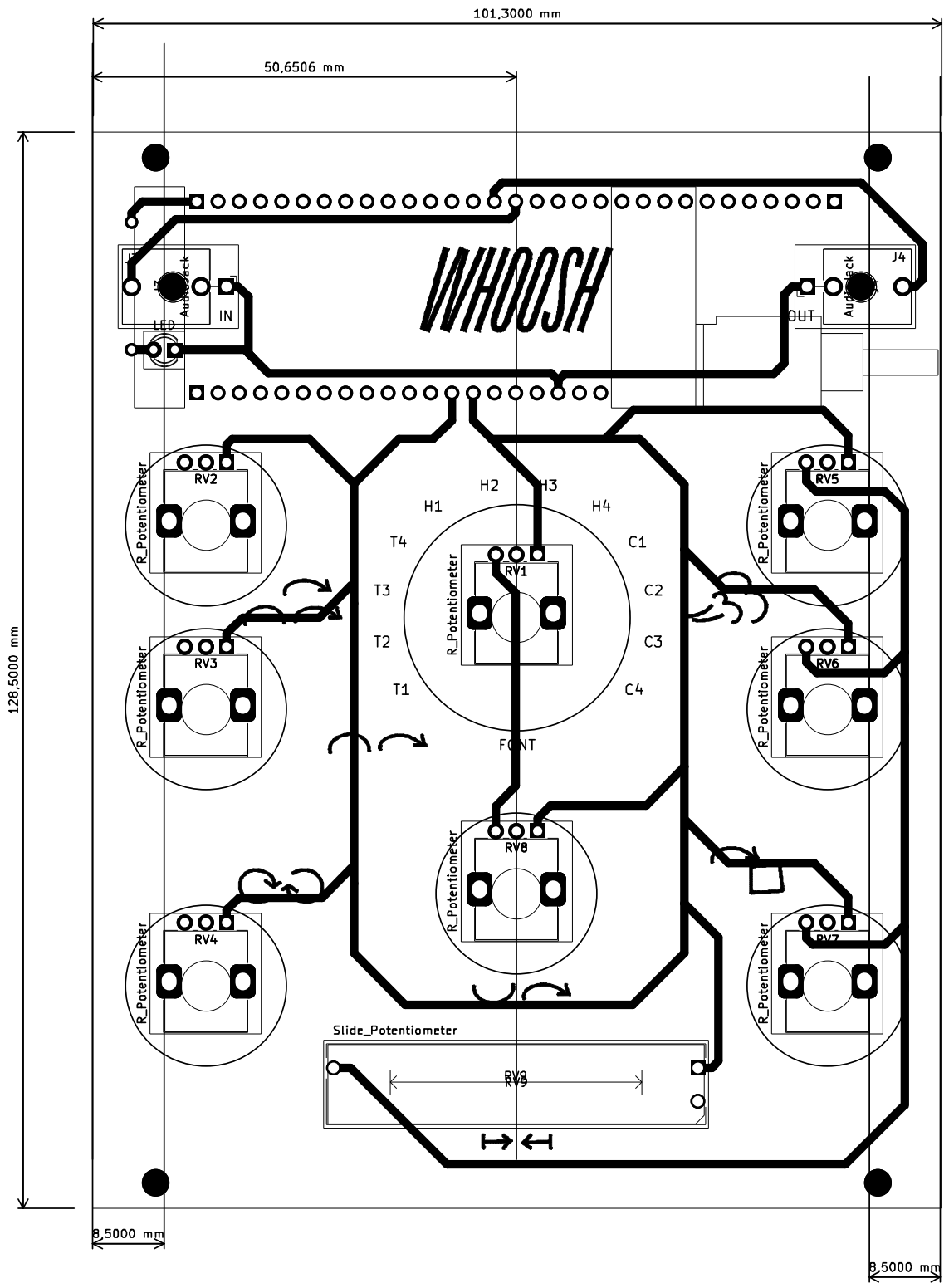

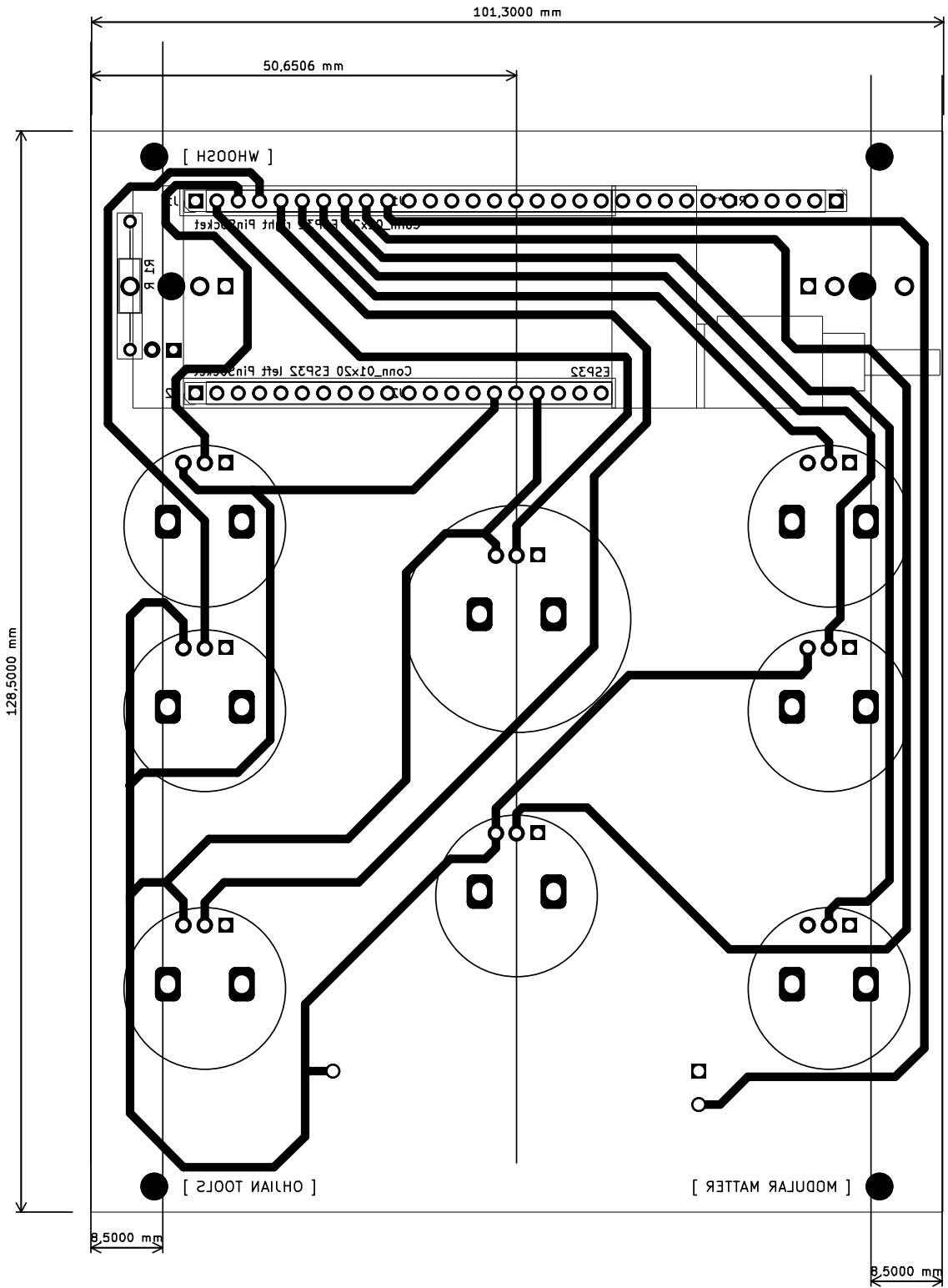

EMERGENT MATTER

[Title]

Emergent Matter

[Module Type]

Output Module

[Description]

The output module *Emergent Matter* can be used to generate a printable file and send it to the printer or the preview screen.

[Instructions]

The *Emergent Matter* module should be the last module of any custom workflow. The input socket should be connected the previous transform module. After adjusting the settings on all modules in the workflow, the print or preview button has to be pressed to send the output to the printer or screen.

[Settings]

The table lists all adjustable components of the *Emergent Matter* module, as well as information about the parameters they affect.

<i>parameter</i>	<i>component</i>	<i>value range</i>	<i>description</i>
input	patch cable, socket	connected / not connected	connects the input socket of this module to the output socket of the previous module
preview	push button	button pressed / not pressed	generates and sends file for preview on the screen
print	push button	button pressed / not pressed	generates and sends file to the printer

[Tips & Tricks]

- [1] Use the preview before printing to prevent surprises!
- [2] Some operations involve random functions, so while the settings on all module stay the same, the preview and print output might change a little with each submission!

[Technical Data]



[Setup]

- 1 audio jack
- 2 push buttons
- 1 LED, 3 mm
- 1 resistor, 1k
- 1 pin header, 2 x 20 sockets

add: 1 Raspberry Pi Zero + power supply; 1 screen + HDMI cable and power supply; 1 printer + USB cable and power supply; audio patch cables; 4 M3 bolts + nuts

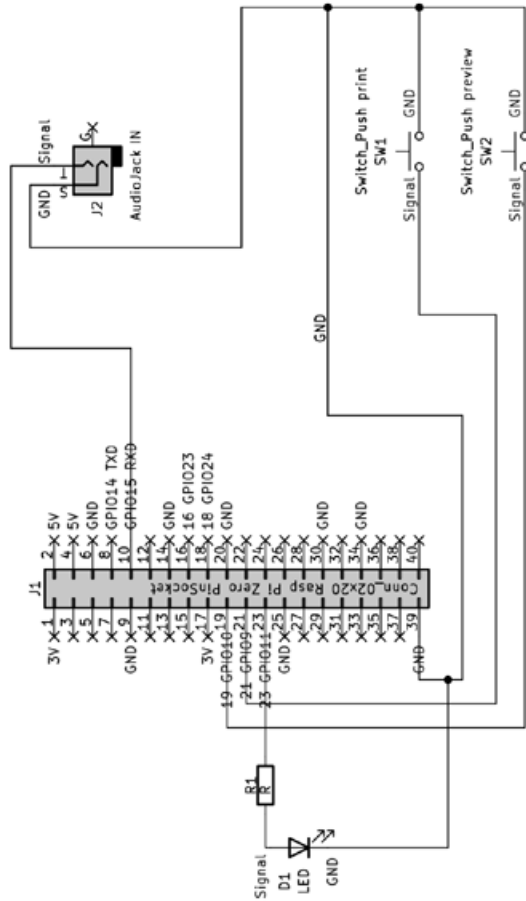

Raspberry Pi Zero

1. read incoming values from: 2 push buttons
2. receive serial data (RX) via 1 audio socket
3. send values to LED

ohjian tools

Sheet: /
 File: emergent_matter.kicad.sch

Title: MODULAR MATTER - EMERGENT MATTER

Size: A4 Date: 2023-05-24

KiCad E.D.A. eeschema (6.0.10-0)

Rev: 1
Id: 1/1

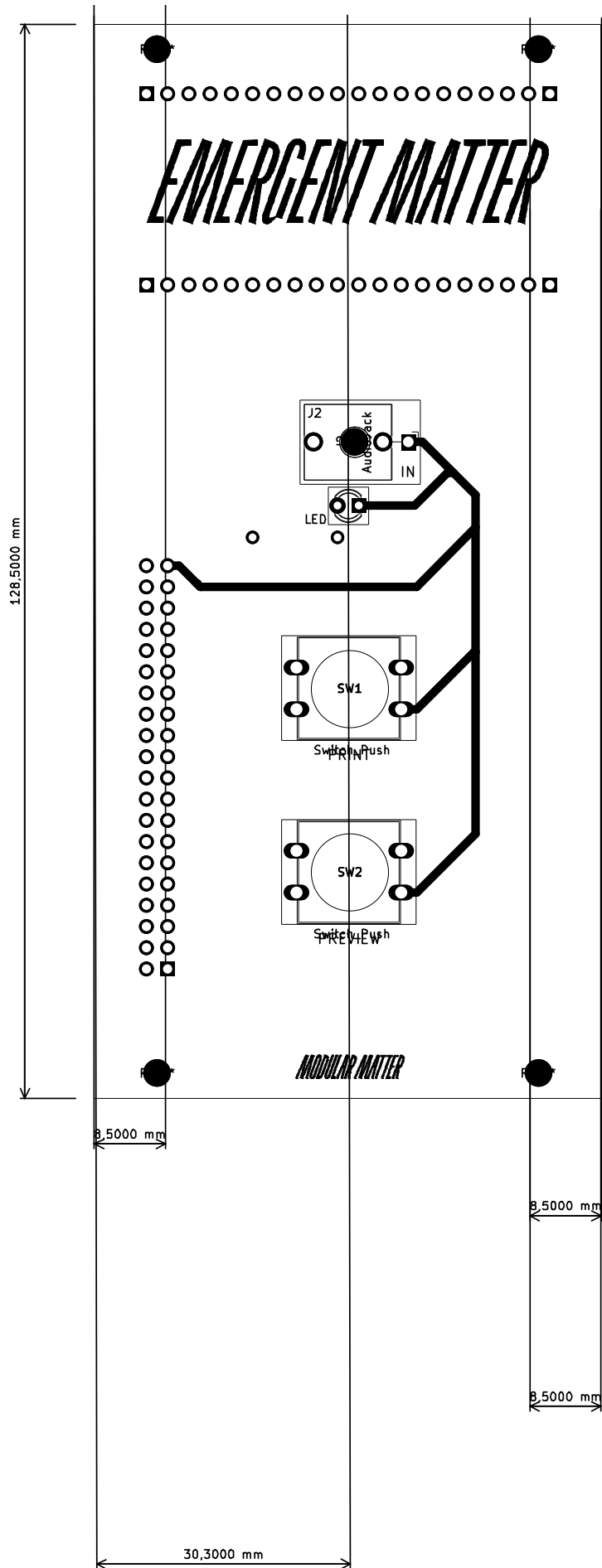

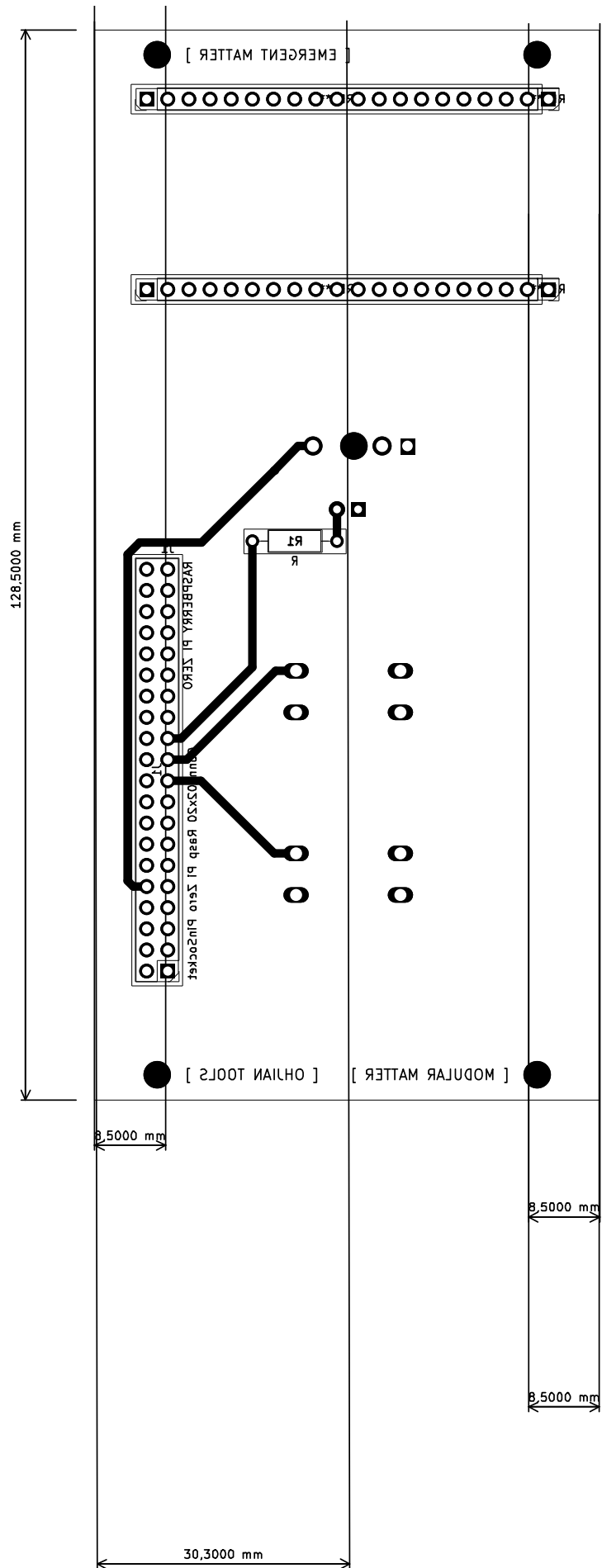







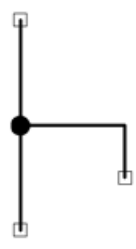
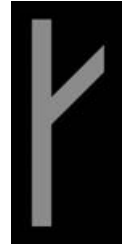

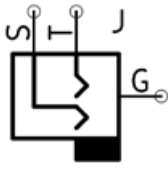
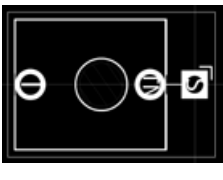

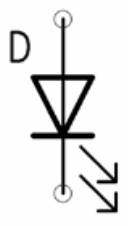





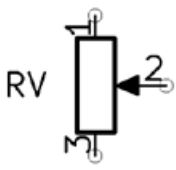
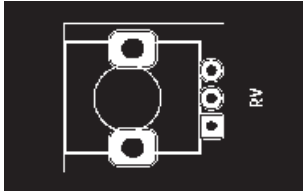



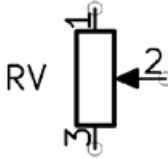
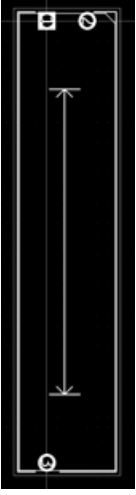

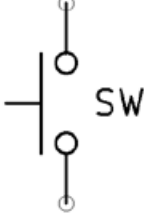
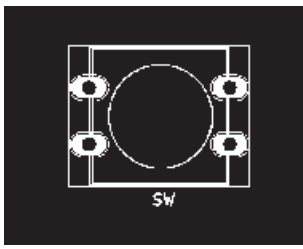

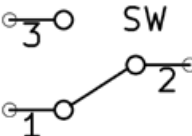
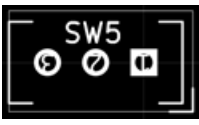

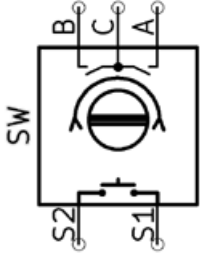
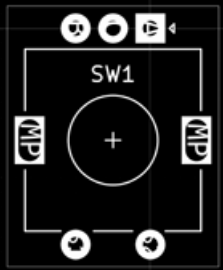

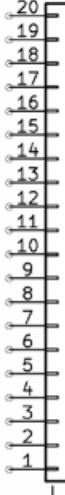
4.3) Reference data-sheet

All hardware modules are built with a variety of different components. This data-sheet gives an overview of the most frequently used components.

In the technical schematic of the electronic circuits they are represented by a standardized symbol. For the design of the Printed Circuit Boards the same components are represented by a footprint that functions as a placeholder for the actual physical component on the board.

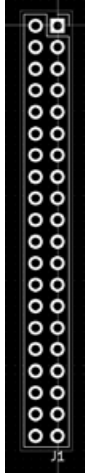
component	photo	symbol	footprint
wire			
audio jack			
LED			
Resistor			
rotary potentiometer (variable resistor)			

component	photo	symbol	footprint
Slide potentiometer (variable resistor)			
switch (push button)			
small switch (slide)			
rotary encoder			
pin header 1x20			

component	photo	symbol	footprint
pin header 2x20			
LCD display			
ESP32			
Raspberry Pi Zero			

5) MODULAR MATTER – Rewire your Prints!

The development of *MODULAR MATTER* continues to be an ongoing work in progress. Nevertheless, the following section can be read as a conclusion to evaluate the tool and to reflect on how the concept of *Modular Synthesis* may be a simple yet fruitful attempt to re-think *Desktop Publishing*.

The basic infrastructure of *MODULAR MATTER* is fully set up and ready to use. It consists of a *Print Module*, a *Preview Module* and several *Transform Modules*, which are in an ongoing phase of refinement. The tried and tested interventions on text and images are simple, yet effective: They create ever-changing and surprising outcome and employ new, exciting ways of print publishing. *MODULAR MATTER* appears to be a qualified tool for experimental processes, drafts and small scale publications.

Simple print productions, such as a poster series, benefit from the unfamiliar setup: The user has to let go of habitual precision and perfectionism and instead welcome happy accidents and little failures. The focus shifts from the final outcome to the process of creating, which attains playfulness and curiosity and provides new impulses for graphic designers and creative makers alike.

That being said, the usage of *MODULAR MATTER*, with all its hardware modules, knobs, switches and patch cables, can be a bit bulky at times. This is why complex projects and publications, especially those that require preciseness and efficiency, may remain an exception.

Having a closer look at the human-machine-interaction, especially in direct comparison to traditional *Desktop Publishing*, the physical interfaces of the hardware modules create a very different design experience: Patching cables, turning knobs and pushing (physical) buttons feels very unfamiliar in the context of print design. The unusual, tangible and sometimes clumsy interaction leads to a more conscious and intuitive control of the device. These small, physical gestures and interventions may be a way to reclaim agency in an otherwise detached human-computer-interaction.

Additionally, the hands-on approach offers an embodied experience of the underlying processes at work. The modular workflow inspires various new combinations and helps to reach a better understanding of the operations that take place. By re-wiring the modules in all possible variations, the user has direct influence on the infrastructure, workflow and outcome. This freedom to reconfigure has a profound effect: By employing *MODULAR MATTER*, the user is virtually building their own tool. This leads to an interesting and ongoing ping-pong effect between tool and practice. A certain configuration of the setup shapes the outcome, which in return provokes a reconfiguration of the tool, and so on. In other words, the practice directly feeds back into the shaping of the tool.

Another interesting aspect of the modular setup is the possibility of collaboration. Due to the fragmented workflow, the tool can be operated by more than one user, which allows for a collective design approach and enables playful and interactive ways of working. The literal entanglement of the physical hardware modules manifests their complex interrelations and interactions. Similar to the single modules in the setup, a group of users may explore interesting and new ways to listen and respond in a collaborative design workflow.

When imagined in an educational context, such as a workshop setting, *MODULAR MATTER* might not only initiate co-creative experiences and produce exciting outcome. At the same time, it could help participants to let go of engrained ways of working and spark critical conversations around tool ecologies in graphic design. 😊

- 😊 *Over the past years I have been hosting summer schools for graphic design students. MODULAR MATTER will become part of my future sessions and workshops.*

While the setup of the overall technical infrastructure has been completed for the time being, there is still room for further additions and features, especially in the form of *Transform Modules*. 😊 A big part of these future imaginaries is not only to add more modules, but also to publish *MODULAR MATTER* in the public domain. Sharing and explaining the technical processes at work will provide access to other graphic designers and hopefully invite peer developers to build and add their own modules to the workflow.

- 😊 *For example, I would like to experiment with looping modules, drawing modules and operations that generate and transform both the styling of text as well as the text itself.*

Dear readers,

the attempt to re-imagine Desktop Publishing through the concept of Modular Synthesis has in many aspects been a very rewarding experience. Whilst MODULAR MATTER was never meant to fully replace established ways of working, the process of making the tool has yet helped me to re-think and re-configure my own tool ecologies and print practice. By reflecting on the impact that tools have on my practice, I was able to recognize the limitations and dependencies that come with it. Even more so, I was able to explore some counter strategies and realized the possibilities and impact we as creative makers have in using and shaping our toolkits.

Proprietary tools and devices have significantly shaped and accompanied my practice over the past ten years. They are very much part of my skillset and will remain in my toolkit. However, I will certainly assign them to a different role: They will no longer be the undisputed number one solution. Instead, I will use them more scarcely, consciously and critically. Especially in moments that require creativity and inspiration over efficiency and flawlessness, I am excited to bring in a variety of new and alternative tools, as well as my own tools, embracing different ways of working and making.

I will continue working on and with MODULAR MATTER, and I want to invite you to do the same: Work with it and make with it! Hack, mis-use or re-purpose it! Test and bend its limitations and possibilities and start to Rewire your prints! Add your own modules and features to the setup! Or, just leave it and try to make your own tools! Slow down your creative process and make it unfamiliar, tangible and situated! Embrace clumsiness and be open for the unexpected! Explore the detours, off-roads and so-called dead ends! There, you will hopefully find some inspiration and encouragements for your own future makings.

References

Culkin, J. (1967) 'A schoolman's guide to Marshall McLuhan', *The Saturday Review*, 18 March 1967, pp. 51-53, 70-72.

Groten, A. (2019) 'Hacking & Designing: Paradoxes of Collaborative Practice', in Bogers, L. And Chiappini, L. (eds.) *The Critical Makers Reader: (Un)learning Technology*. Amsterdam: Institute of Network Cultures, pp. 237-244.

Hertz, G. (2016) 'What is Critical Making?', *Current*, 18 April 2016. Available at: <https://current.ecuad.ca/what-is-critical-making> (Accessed: 13 April 2023).

Howell, B. and Pogorzelskiy, M. (no date) *The Screenless Office*. Available at: <http://screenl.es> (Accessed: 13 April 2023).

Korsten, F.-W. (2022) 'criticality', in Wesseling, J. and Cramer, F. (eds.) *Making Matters. A Vocabulary for Collective Arts*. Amsterdam: Valiz, pp. 105-112.

Make Noise (no date) *Echophon, MATHS and Function*. Available at <https://www.makenoisemusic.com> (Accessed: 13 April 2023).

Make Noise (no date) *The Pillars of Hercules*. Available at <https://www.makenoisemusic.com/content/manuals/EchophonManual.pdf> (Accessed: 13 April 2023).

Manovich, L. (2013a) 'Software is the Message', *Software Studies Initiative*, 17 December 2013. Available at: <http://lab.softwarestudies.com/2013/12/software-is-message-new-mini-article.html> (Accessed: 13 April 2023).

Manovich, L. (2013b) *Software Takes Command*. New York: Bloomsbury Academic.

McLuhan, M. (1964) *Understanding Media: The Extensions of Man*. 1st edn. New York: McGraw-Hill.

Open Source Publishing (no date) 'Tools', *Open Source Publishing*. Available at <http://osp.kitchen/tools/> (Accessed: 13 April 2023).

De Heij, G. (no date) *TOOLS SHAPE PRACTICE SHAPES TOOLS*. Available at <https://www.burg-halle.de/design/kommunikationsdesign/kommunikationsdesign/lehrangebote/l/tools-shapes-practice-shapes-tools/> (Accessed: 13 April 2023).

Pater, R. (2021) *CAPS LOCK. How capitalism took hold of graphic design, and how to escape from it*. Amsterdam: Valiz.

Ratto, M. and Hockema, S. (2009) 'FLWR PWR: Tending the walled garden', in Dekker, A. and Wolfsberger, A. (eds.) *Walled Garden*. Amsterdam: Virtueel Platform, pp. 51-60.

Snelting, F. (2008) 'Awkward gestures: designing with Free Software', *Freeze+Press*. Available at: https://freeze.sh/_/2008/awkward/# (Accessed: 13 April 2023).

Colophon

This work has been produced in the context of the graduation research of Jian Haake from the Experimental Publishing (XPUB) Master course at the Piet Zwart Institute, Willem de Kooning Academy, Rotterdam University of Applied Sciences.

XPUB is a two year Master of Arts in Fine Art and Design that focuses on the intents, means and consequences of making things public and creating publics in the age of post-digital networks.

<https://xpub.nl>

This publication is based on the graduation thesis

MODULAR MATTER – Rewire your Prints!
A Situated and Annotated Manual

written in 2023 under the supervision of Marloes de Valk and Joseph Knierzinger.

This thesis can be copied, distributed and modified under the Free Art Licence 1.3

Find more information on the project here:

https://git.xpub.nl/ohjian/MODULAR_MATTER/

https://pzwiki.wdka.nl/mediadesign/User:Ohjian/Final_presentation

<https://project.xpub.nl/modular-matter/>