

THIS  
DOCUMENT  
IS A WORK IN  
PROGRESS

DO NOT  
USE FOR  
REFERENCING  
QUOTING OR  
ANY FORMAL  
OR INFORMAL  
USE

THANK YOU  
(-:

15.06.2023



The social shelves project  
in short: sustainable,  
economic, 'transparent'  
designs. An idealistic  
approach to making  
considering whether

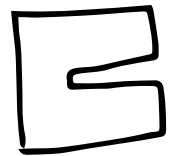

— small designs made in  
contextual situations and  
for the local by the local  
can create new strategies  
for people to bond with  
their surroundings

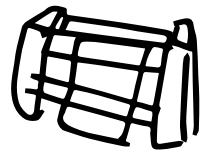

— more empathetical  
relationship to objects  
can bring social change.

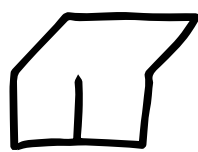

Material  
Reviews:  
the social  
shelves project

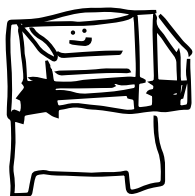
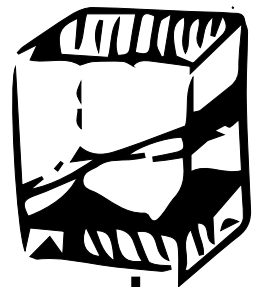

by Gersande Schellinx

# Disclaimer

This is not a work of fiction. The Material Reviews of the social shelves project are a personal recounting of my experience prototyping and building 'social shelves' between 2022 and 2023.

Names and other details have been changed to protect the privacy of certain organisations and individuals. The political beliefs, social dynamics, moral and economic values of the different contexts for which those objects have been produced vary. As to not melt those different layers into one, some contexts will be reduced in our text to an abstraction of their spaces.

Circumstances have led me to produce objects for those different places. Some places I have been invited in, others, I have offered my help, or am familiar with. These different locations illustrate the variety of material needs that emerge in different contexts. The diversity in networks created an opportunity to illustrate how the necessity for small designs is omnipresent, even if it varies in form and urgency. My attempt to facilitate encounters bringing people and objects together has allowed me to better grasp the implications of different material narratives. It has been a humbling and exciting experience altogether.

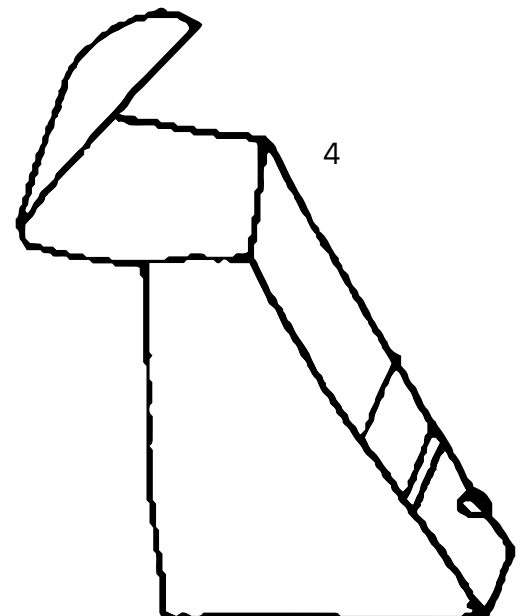
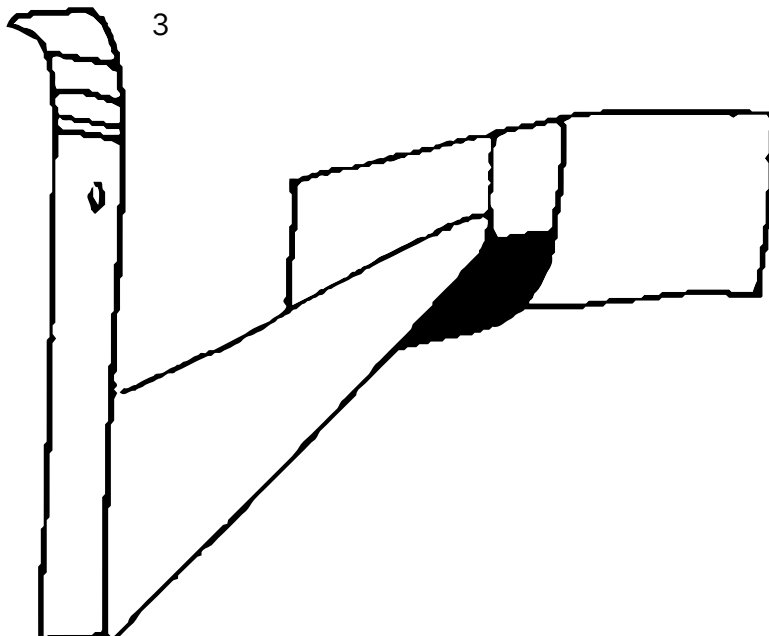
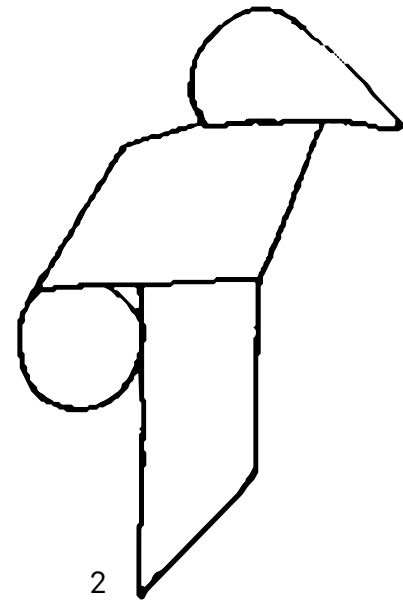
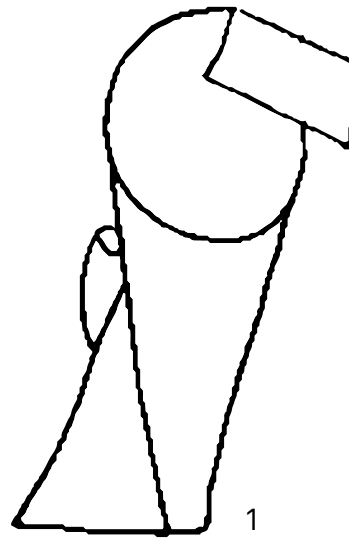

# Discussion with H

Location: Amsterdam  
01.06.2023

G: I've been working on something called the social shelves project.

It started with an object given by my mother years ago, an old antique book support/end. I've been calling a shelf, because you can travel with it, unfold it in any location so that you always have a bookshelf with you.

I wanted to focus on that one object in the context of my master. The hosting space, the small scale of the object that allowed for more experiments and prototyping. I thought 'let's call it "social shelves"', to cover every possible type of shelf: 'book support, bookends, bookshelf, case...' anything related to this and not limited to books. I wanted to really focus on the object, without a priori limiting what should go on it.

I decided to build five different social shelves. Ultimately, my fantasy around the project was 'how do we make small designs more accessible to create more custom-made but still sustainable and affordable objects'. Ideally, I would have gone to different places and help people make these objects for themselves; me, acting as a facilitator, rather than a designer-author.

Because of the time restrictions and the need to do more research on these topics, I decided to cut the workshop aspect for now. Instead, I searched for places in different contexts in need of shelves.

The shelves that come out of this are all to me prototypes of what can be. They are not end products.

H: Yeh, always a work in progress.

G: Yeh case studies for these contexts.

Can we do these small designs? The idea is that also if you can understand how they are made, you can also repair them easily or reproduce or... You don't have this helplessness that a lot of people have with the objects around them that if something breaks it becomes obsolete.

Their premature obsolescence creates a lot of waste.

The last one which is not published yet... Oh yes, I started to think about the moment I let the shelves be in their context as a publishing moment. I haven't 'published' P. Enches yet, it is still in my studio.

H: Publishing the shelves!

G: I don't want to display [in the graduation show] these objects that are not in context, because it would turn them into products. So for the show I want to only have the suitcase on display. I'd rather build new shelves for the show that are in context than bring the other ones out of their context. I'm not gonna build a bench for this object [P. Enches] for example. But what happens to it if I show it without a bench?

How will I make shelves for the show? C said 'oh we have all these scraps'; for me this was very exciting because I'd much rather work from these than make a design that needs a very expensive material base to be obsolete after three days, it's such a waste.

H: Totally, and I also think that, using scrap material gives it an ongoing life and I think that's really nice. How do you do something with cheap materials and also accessible building methods, the process of building together and all that kind of stuff...

# where are the social shelves?

29.06.2023

As my studies come to an end, etiquette wants me, as a student, to display both my research and the works I have produced in that period of time. In June of 2023 an exhibition will take place at WOW in Rotterdam. Eleven artists and designers, including myself, are graduating from the Experimental Publishing (XPUB) master. Time to shine: this is our graduation show.

But, the objects in this publication live in another space. One that does not belong to the space you are currently in. You do not need these specific objects to be in front of you to reflect on them. If this publication reaches you after this 'show moment', you should know that most of the social shelves weren't exhibited on the occasion.

Where are the social shelves?

Despite this being a much anticipated moment to exhibit my 'skills' to the public, I decide a few months before the show that I won't present, physically, most of the objects I have built in these past six months.

Why this resistance to show what most would consider as my designs? There is this reluctance on my part to be considered as designer-author. I consider my real achievement of this experience to be the process that led me to conceive those objects rather than what most would consider as the 'end-products' themselves. I want to position myself as a mediator and facilitator, not as designer-author. To present those objects as supposedly 'end-products' would put a premature end to this inquiry. Yet it is not over and will continue after my graduation.

In this context, the thought process of how to conceive something supersedes the item itself, that is what has been made. I want to invite others to participate in this experience to find ways to create more adaptable and more sustainable approaches to design. So what could be better to circulate this project than turning it into a publication?

A temporary exhibition space is an unsustainable space. It displays what you want others to see, but only for a limited time. It shows but it does not keep showing after a certain date.

The social shelves built for this project have already been 'facilitated' into their dedicated spaces. It felt contradictory to the aim of this project to tear them away from their publication space just to display them temporarily in one where they have no real use. The briefness of a graduation show does not align with the philosophy behind the social shelf project that wants to live on and adapt in various spaces, not of display but of actual use. This refusal of exhibit my work is therefore not meant to challenge the legitimacy of exhibition spaces.

In my previous education, I produced a lot of things for hypothetical or fictional spaces, performative artefacts that didn't respond to any real-world needs. Made in unrealistic circumstances, they were unsustainable, unaccessible, unreproducible and unaffordable.

The social shelves project challenges these issues resulting from a deep contradiction between, heavy production, for too short activation time.<sup>1</sup>

I also want to question design authorship. When do I own a design? Or an object? All the shelves I have built were meant to answer specific needs, instructions or time, space, and material restrictions in relation to the context and use of shelves.<sup>2</sup>

I did make some technical and material choices to translate those needs. I sampled already existing designs, re-appropriated

features found in existing objects and adapted to the materials available in those contexts. As such, I consider myself to facilitate the becoming of these objects, rather than owning them or claiming authorship over them.

Instead of defining myself as the designer-author I have trained to become, I have chose to take on the role of a mediator between contexts and objects, a facilitator for materiality to enter in a dialogue with its surroundings. My practice is about engaging with the need of a place, putting accessibility and sustainability at its core, not superfluous performativity. It considers how we can create an empathetical bond with our environment through small designs? A material kinship of some sort, uniting people and objects.

The social shelves are already where they ought to be. They have espoused the context for which they were conceived. This, to me, is their true achievement.

<sup>1</sup> Time spent planning, producing and making something. Financial investment unrealistic on larger scale or in an economic exchange. Unpaid labour. Unreproducible designs... I don't take pleasure from the contemplation of a completed project. I take pleasure in its long-term activation, which is when I see it come to life through another's eyes. Projects should be a communal experience not a singular one.

<sup>2</sup> Take my work as a book binding workshop manager at the Gerrit Rietveld Academie. Students come to me with projects that are more or less prototyped or conceptualised. My work is to help them translate their ideas into a material platform I understand the language of. Do I consider myself an author of those projects? Do I own any of those prototypes? No, I have facilitated the encounter between a person and an object.

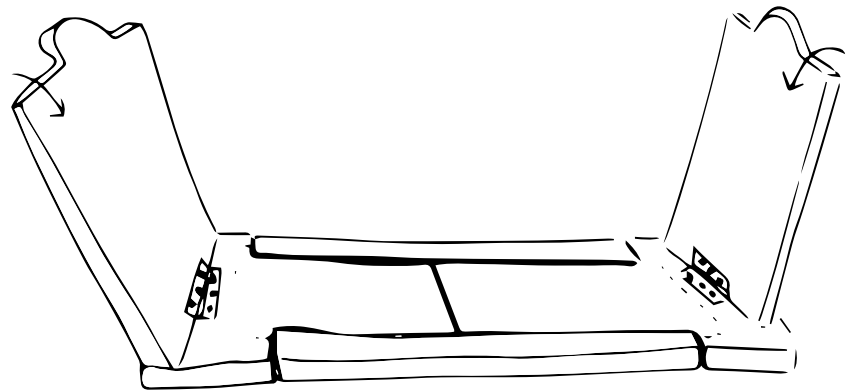

1

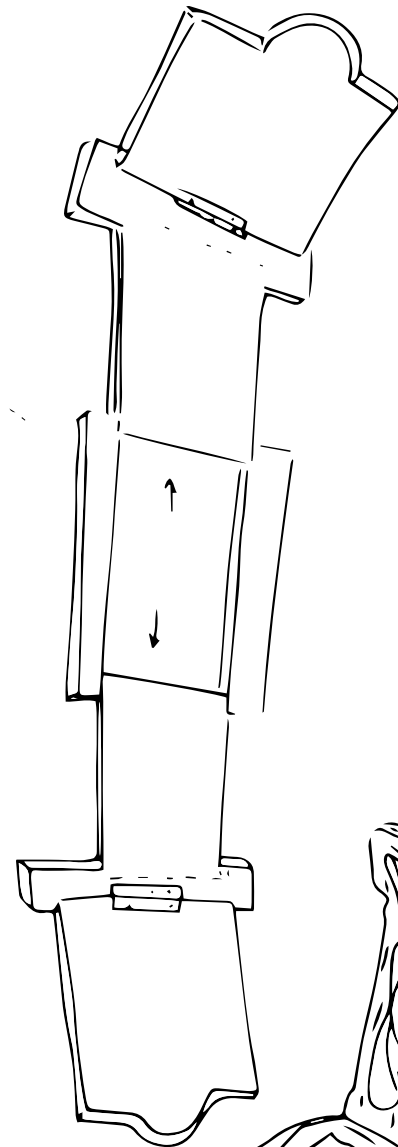

2

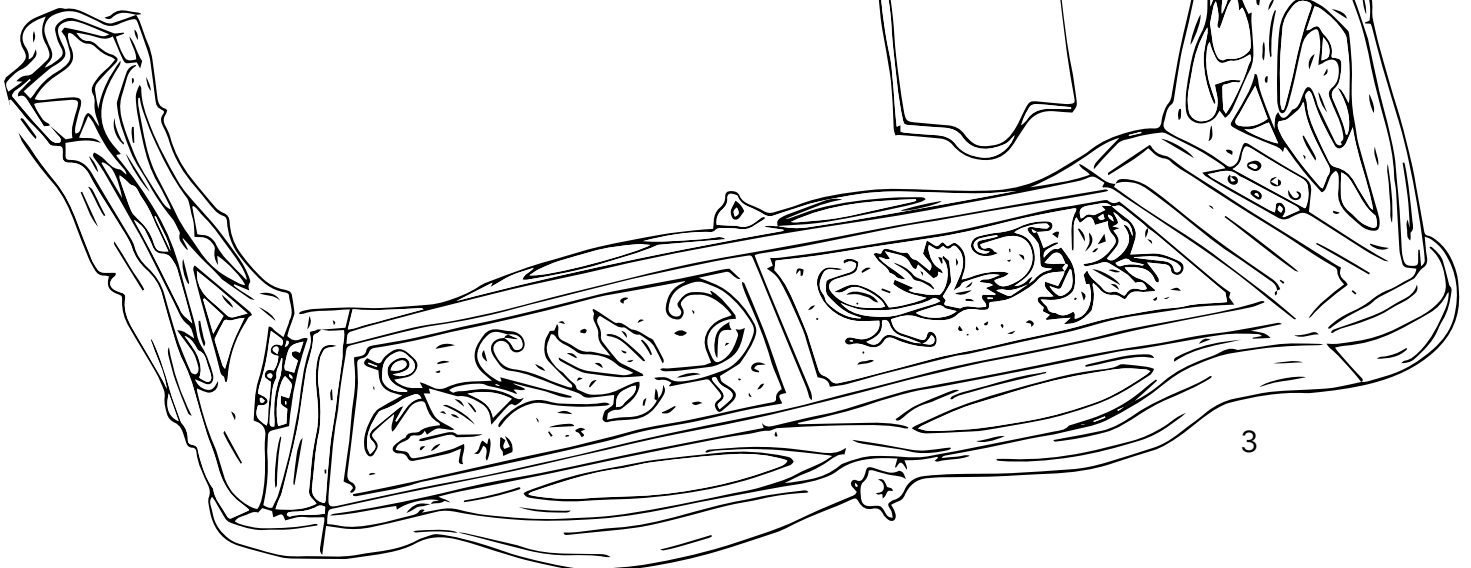

3

# A 'seamless' design

Location: Rotterdam  
Name: B. Zamp  
Publication date: 05.11.2022

The first shelf named B. Zamp (short for 'books zine camp') was made in accordance to this given instruction 'we have a suitcase full of books, from all different sizes, could you make us shelves that would fit all of them and maybe also the suitcase?' (at least that is how I remember it).

November 2022, the Zine Camp in WORM Rotterdam is coming up. M and J turn to me 'wouldn't making the shelf for the XPUB department at the Zine camp be the perfect opportunity to try out your material research?'. And they were right. I had been unsure what would be a good opportunity to put my recent theories into practice.

Immediately, a multitude of possible objects came to my mind. All had at their core, this feeling of a shelf integrated to an already existing suitcase. Strings and knots, ropes and beams, were crossing and folding and weaving into one another in my head, yet nothing seemed to be simple enough or strong enough to resist back and forth transport and allow successive dismantling while also holding all those publications that weighed a significant amount.

Consequently, I started looking into my favourite kind of furniture-object, old carrier-box for cameras, clothes, accessories. A lot of those old artefacts are made out of wood.

Around the same time, we had an event at the Leeszaal in Rotterdam with XPUB, a library for books obviously, but also for shelves. All kinds of shelves blossom/arise in this incredible space from the ground up to the ceiling. With cheer excitement, I meticulously documented each of these fantastic objects. One of them, located close to the entrance was a simple box, a diagonal line separating it in two halves that when opened turned into an elegant book display.

With those two artefacts in mind (the carrier-box and

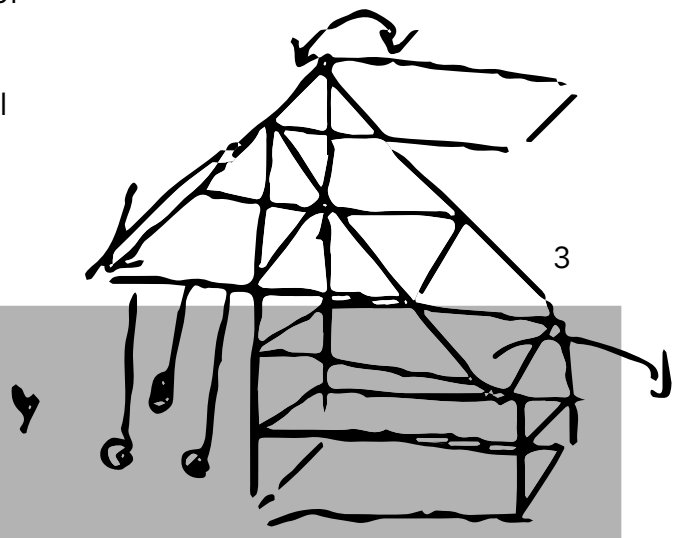
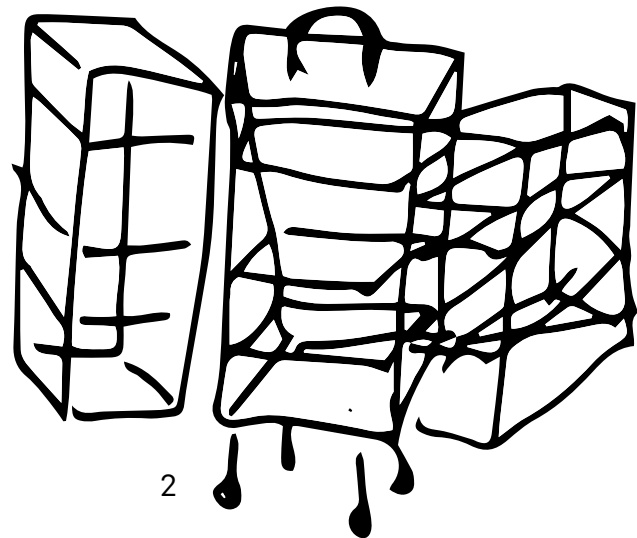
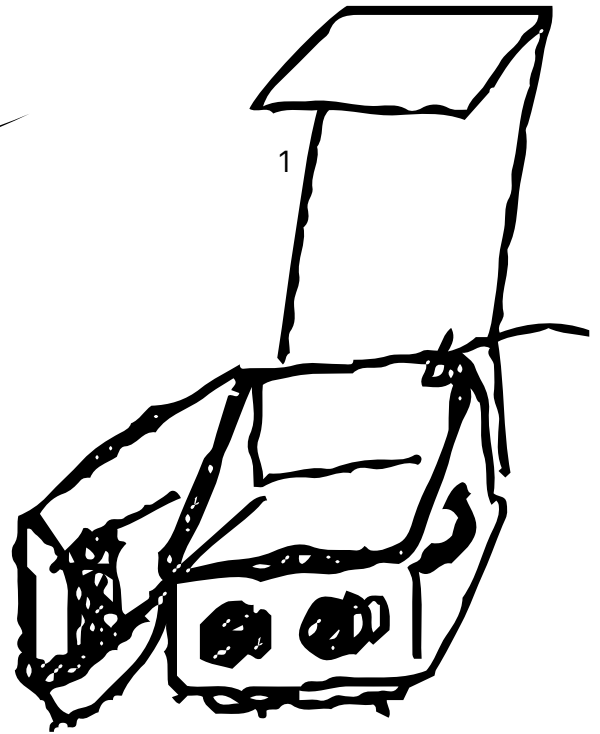



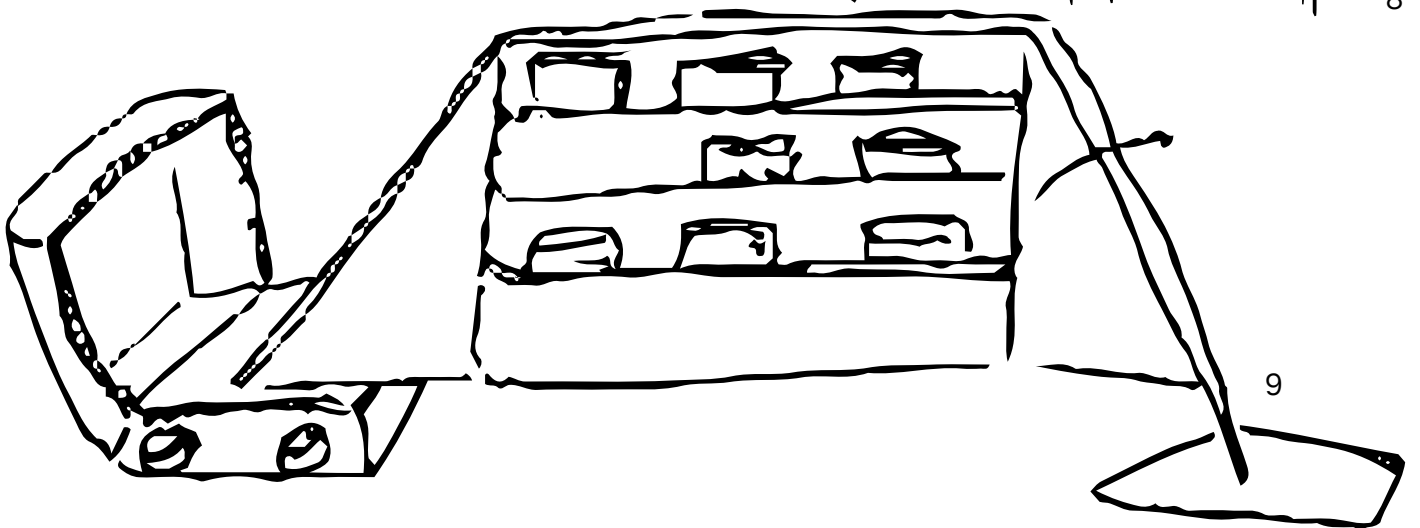
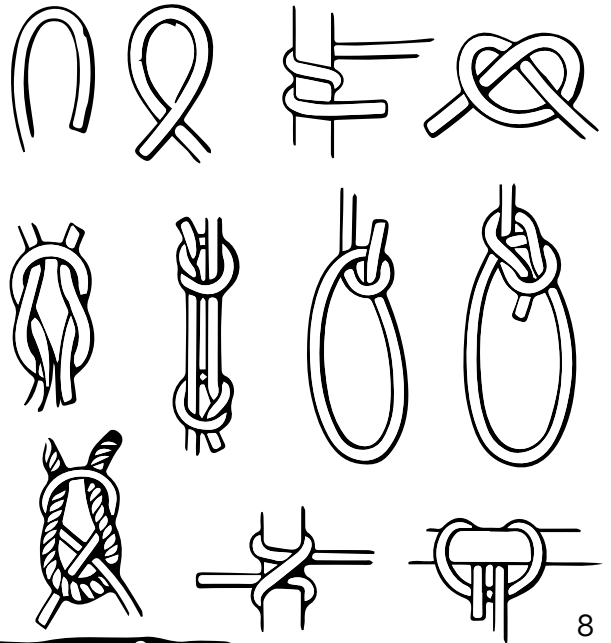
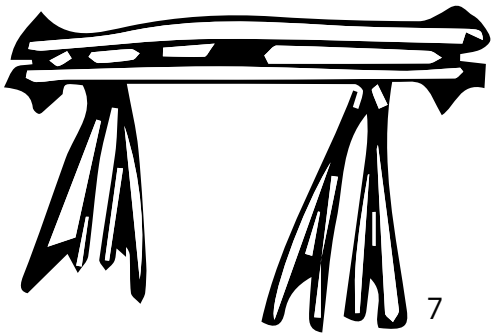
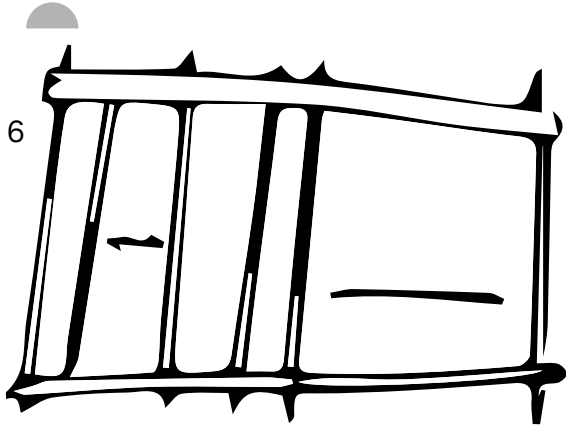
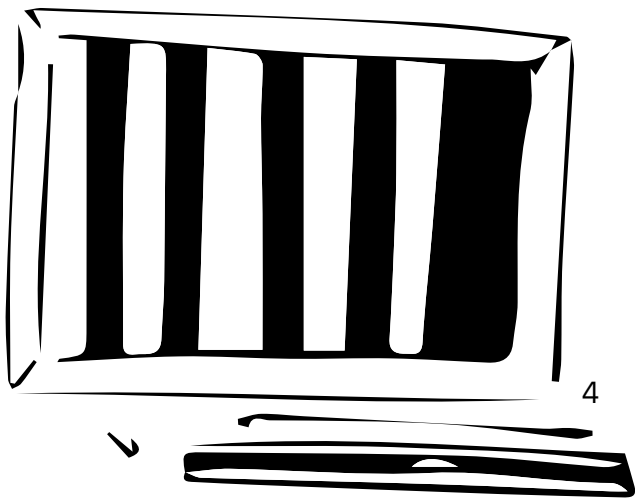



10



11

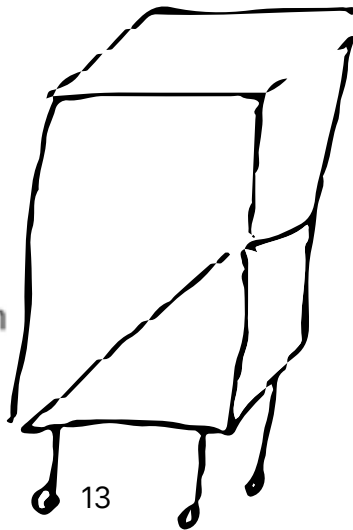

13



14

15

**B. ZAMP**

social shelf 1.  
piet zwart institute x gerrit rietveld academie  
zinecamp 2022 WORM Rotterdam, not just a fair Arnhem  
wood, hinge, screws, wheels, slots  
80cm x 50cm x 30cm

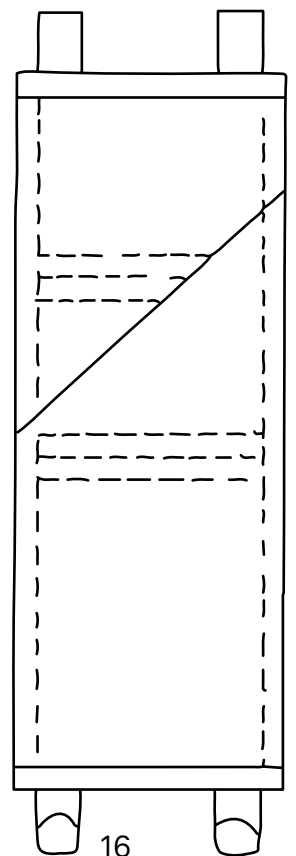

16

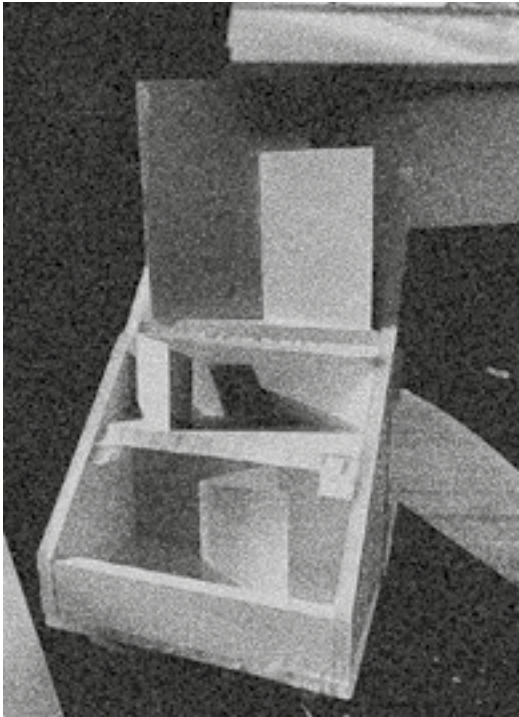

17

the Leeszaal box-book-display) it quickly came to my realisation that while I couldn't fit the perfect shelving system in the suitcase I was given, I could instead build the perfect suitcase to display the shelves. I set the dimensions to an XL suitcase size (around 80 x 50 cm), enough to fill it with publications from all size and shapes.

Just wheel it to the Zine Camp, open it and bam: once the planks on the inside are set, you have a book display and the shelves won't move! A door-to-door salesperson's dream!

Hearing this you might think 'Amazing! You did it! Fantastic!', but actually I failed to succeed. My design had become of such complexity in its seemingly seamless simplicity that it could not live up to the basic requirements of a 'social shelf' to be a 'sustainable, economical, transparent contextual design'.

During this first attempt, I dived into Enzo Mari's hammer & nails designs part of his Autoprogettazione? project. I really look up to his accessible and ingenious designs, that could be altered to the local needs; the importance he gives to method over product, his 'open' designs for every day furniture.

Even though I aspired to create objects of similar simplicity, B. Zamp turned up to become a very complex piece of work. I was given this assignment two weeks before the event. In my rush I unwisely chose to buy new material, including all the accessories necessary to carry it, close it and open it. Which made the cost of the object rise and be more expensive than a simple IKEA BILLY bookshelf!

18



In order for it to open smoothly, the suitcase needed a lot of cuts in a 45° angle. To make those cuts a lot of heavy expensive machinery was used. These tools and the technical knowledge they require are scarce commodities. The same cuts created challenges to screw in the hinges, made for 90° angles, and necessitated adding an extra space onto the object. Making those 'seamless' cuts came at a high material cost and called for extra-material to be added to the edges of the object.

Without the wheels the two parts are of equal height, once the suitcase opens the wheels add height on the lower part. The wooden handles added to the design were meant to prevent that once opened the suitcase's

upper part would float above the ground once opened. The production of these custom handles to a right size (most industrial handles were not solid enough, too small, too big, too round, etc) turned out to be a very specific and difficult process. The wheels needed to support the heavy load were expensive, and it remains hard to pilot on uneven grounds.

Despite all those issues encountered during manufacture. B. Zamp has proven to be the perfect social shelf in the XPUB context. Since its manufacture it has travelled to several events becoming a satellite space for XPUB publications on the road. It easily hosts publications ranging from <A5 to A2> formats, embracing the constantly shape shifting output of students.

B. Zamp has become a token of the master's entity. Easy to manipulate, it can be set up by anyone in the program. It responds to the needs it was set to meet, but ultimately failed to simplify manufacture protocols and means. Hard to reproduce, B. Zamp does not challenge, but reproduces the problems that arise from investment in heavy production cycles.

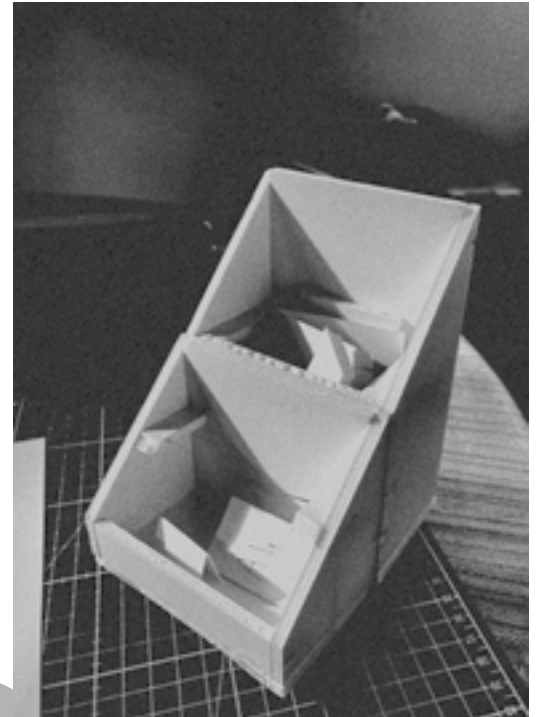

19

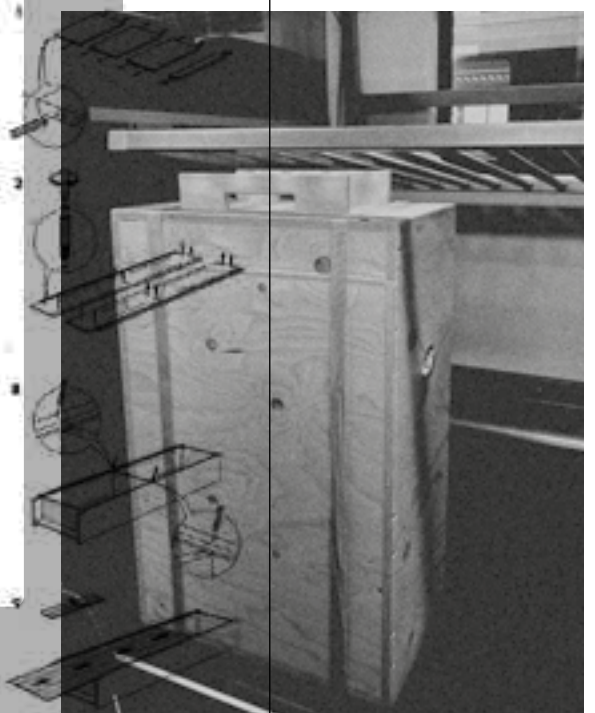
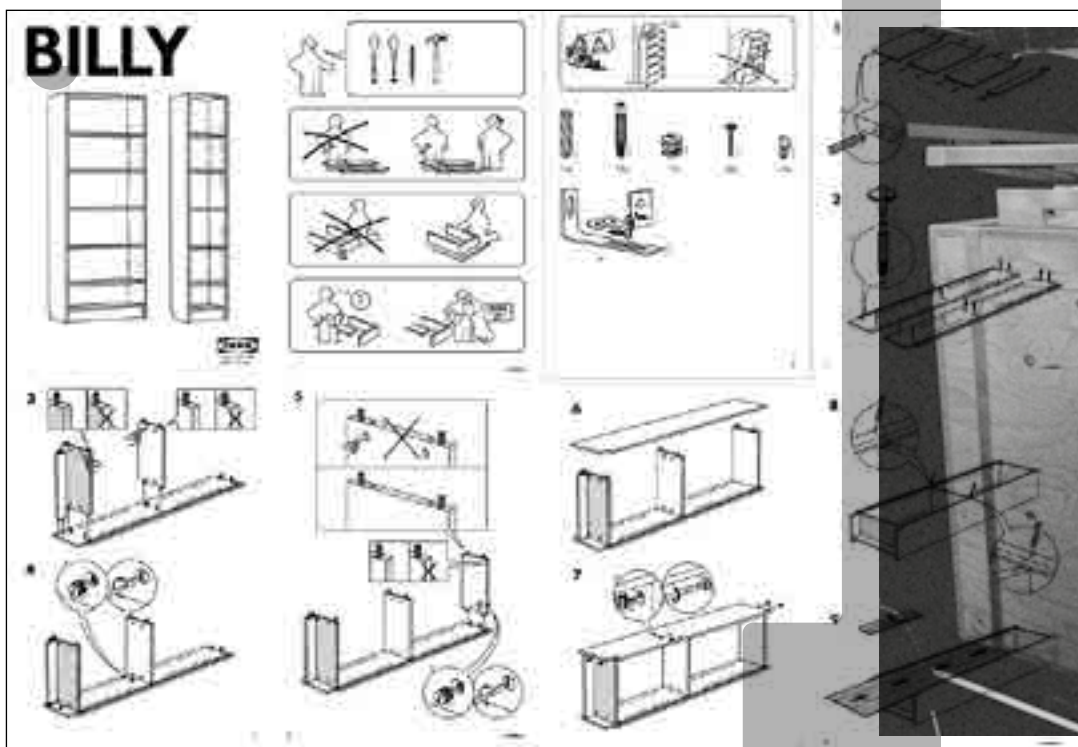



22

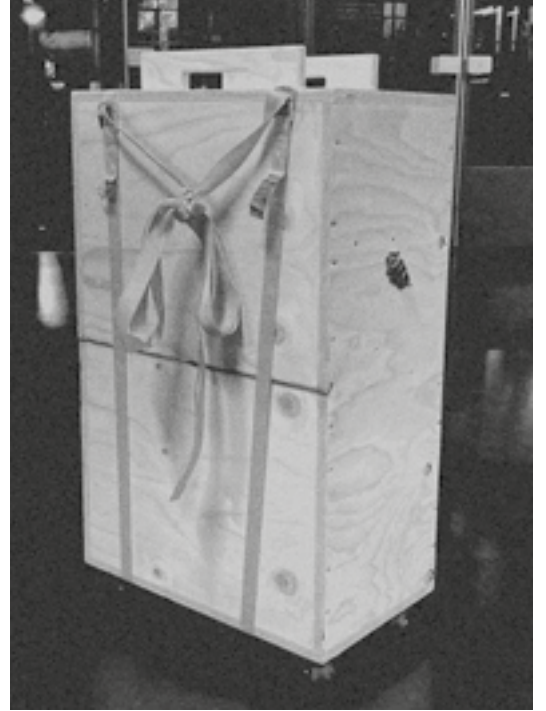

23



24



25

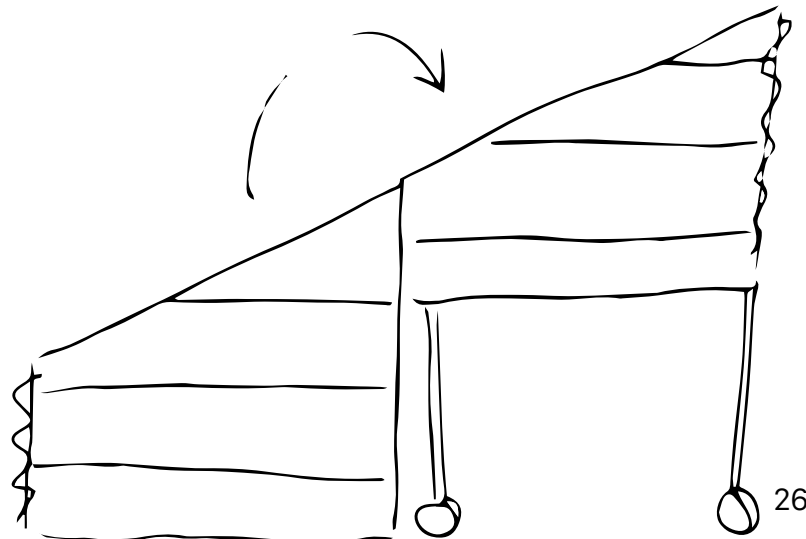

26

# 420. x 297 times three

Location: Amsterdam  
Name: B.B. Wop  
Publication date: 10.12.2022

B.B. Wop (short for Book Binding Workshop) was made with very clear restrictions. No screws, no accessories. One flat surface, easily cut, easily assemble, easily stored. [image sketches]

In the mentality of the BB Tools (designed by my colleagues and produced in collaboration with the book binding workshop and other GRA workshops). 3 The series of objects made since 2019 are meant for students to learn how to make tools by themselves in a collaborative and playful way. Students take part to the making process and get to reflect on the tools they use, understand them better and get agency over a technique, which they can then proceed to reproduce, alter, or re-imagine. [bb tools ads]

Students that come by the book binding workshop always carry papers, prints, dummies with them. Yet they don't necessarily have a space to store, gather or display these materials. B.B. Wop was imagined to be the perfect space for these works in progress to be carried around school, shown to teachers, or stored on desks.

Quickly I decided the design of this shelf should fit on an A3 format. A3 is the most widespread paper format (after A4), readily accessible and easy to copy, scan and reproduce. The design of B.B. Wop soon proved to fit on three pieces of A3.

In the following production stage, the cutting, the flat design, proved to be a perfect fit for the laser cutter: the three A3s took just as much as the maximum size available in the laser cutter available for use at the WDKA (800 x 450 mm, coincidentally the same height and width as B. Zamp). 4 Three A3 turned out to be an optimal size to produce a shelf that has a strong core body and modular pieces that can easily be assembled and taken apart. [A3 images & laser cutter documentation]

If this design is indeed easy to reproduce and

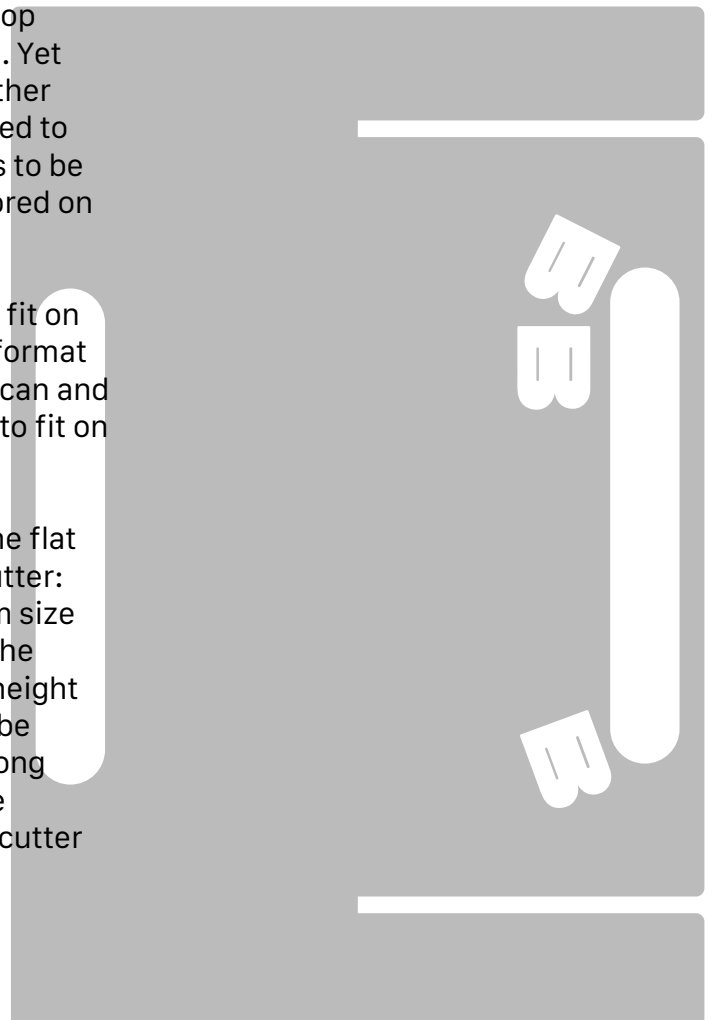
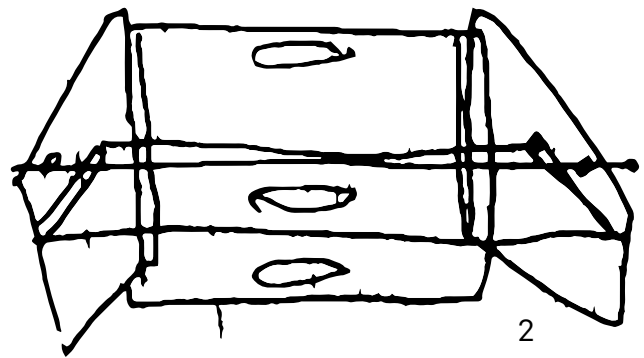
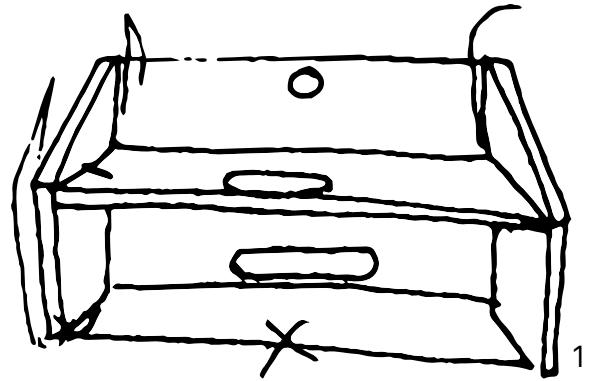

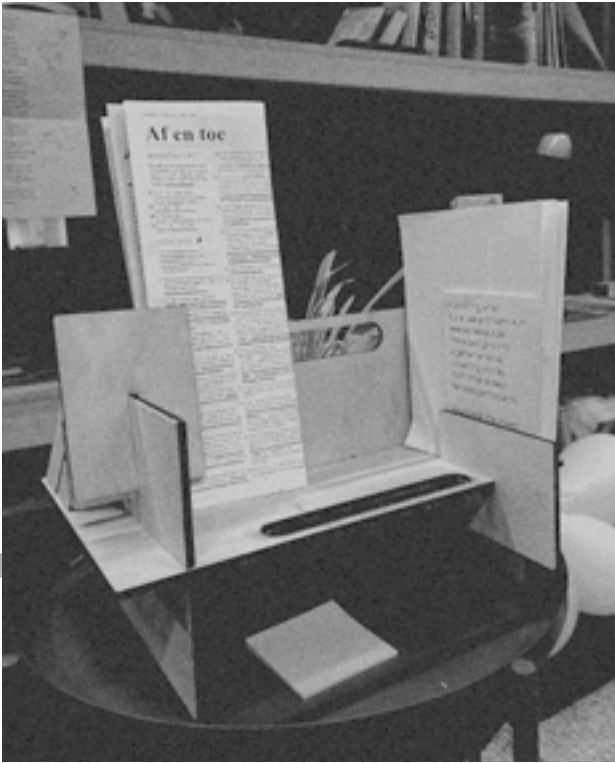

3

4

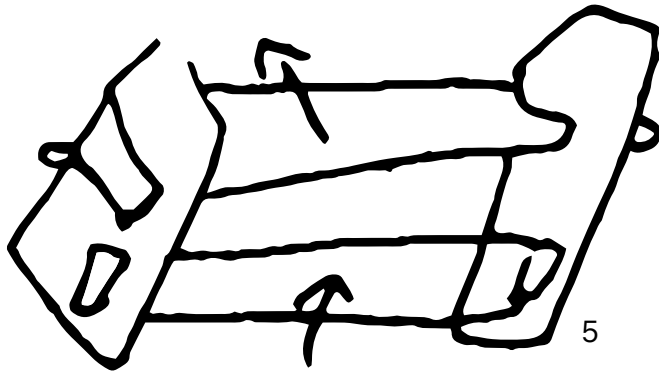
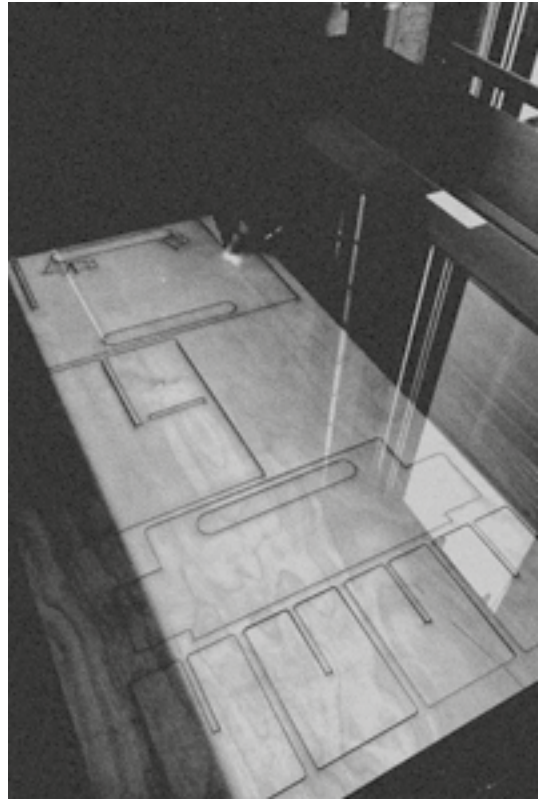

5

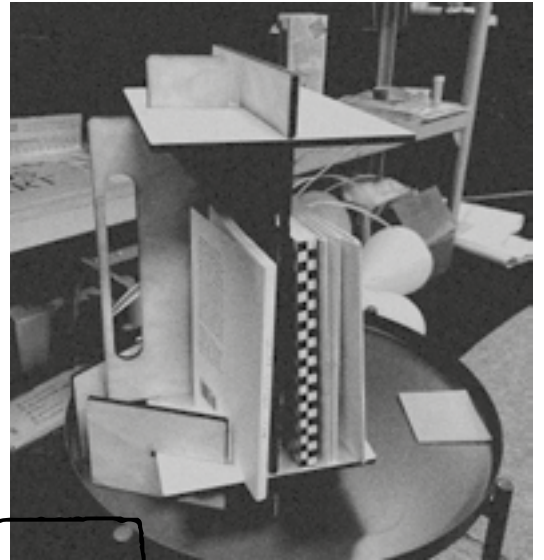

6

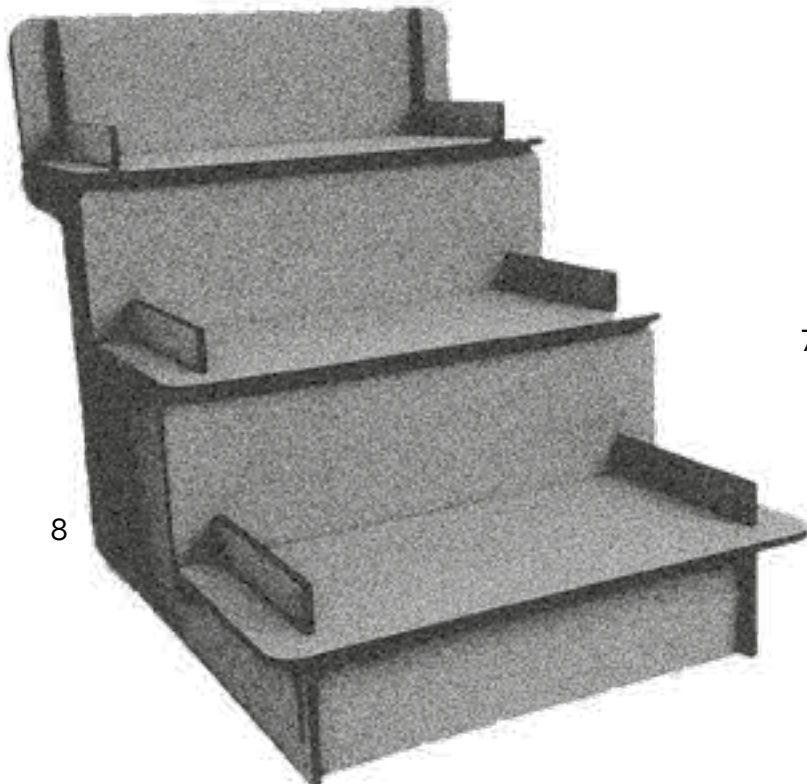

8

7

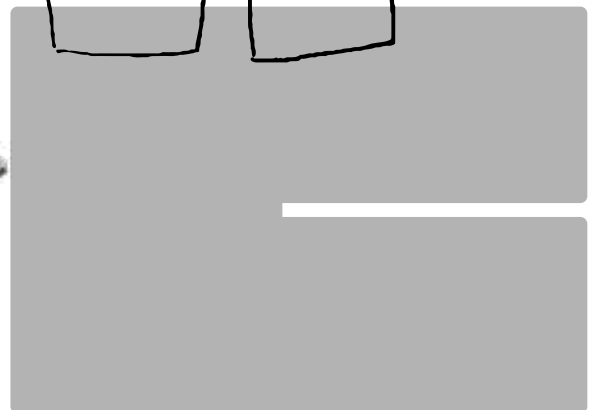

manufacture, the few prototypes that I managed to make between November and December have revealed several flaws.

The thickness of the material used cannot be more than 6mm. The first prototype, made in thick birch wood, proved to be much sturdier than the 3mm acrylic, which next to being too light also proved to be slippery. Thus, acrylic materials would need to be thicker (most wooden materials have a natural grip, especially after being cut) or need some kind of extra accessory locking the different parts into places after being assembled. [pics different prototypes]

The different modes of assembly of the shelf allow some degree of versatility, but because the design fits on A3 sheets, the range of publications formats that it can fit is necessarily rather limited.

Still the A3 format makes the design itself easy to access and reproduce. It also allows the user-maker to alter the design as they please and customise it to their wants and needs. The production of B.B. Wop is not necessarily limited by access to a laser cutter of the right size. The A3 format allows cuts to be done manually using a saw or any kind of cutting technologies less expensive than the laser cutter. [sketch?]

All in all, low cost equipment and material make the B.B. Wop shelf fitted to the context of the BB tool series meant to involve students.

3 BB is the short and affectionate acronym used to refer to the Book Binding workshop. The BB is my workplace at the GRA, short for Gerrit Rietveld Academie.

4 WDKA is short for Willem de Kooning Academie. The XPUB master is located in the same facilities as the WDKA's bachelor programs and uses the same work stations. The laser cutter at the GRA has a maximum size of 800 x 600 cm.

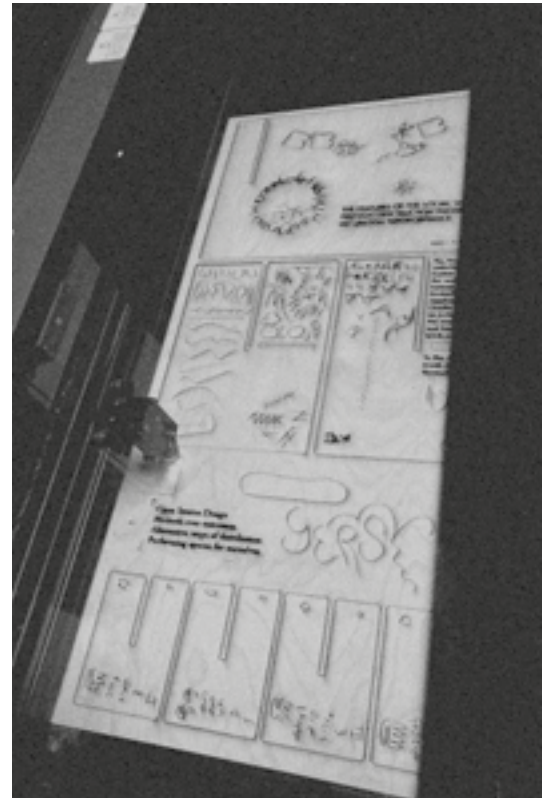

9

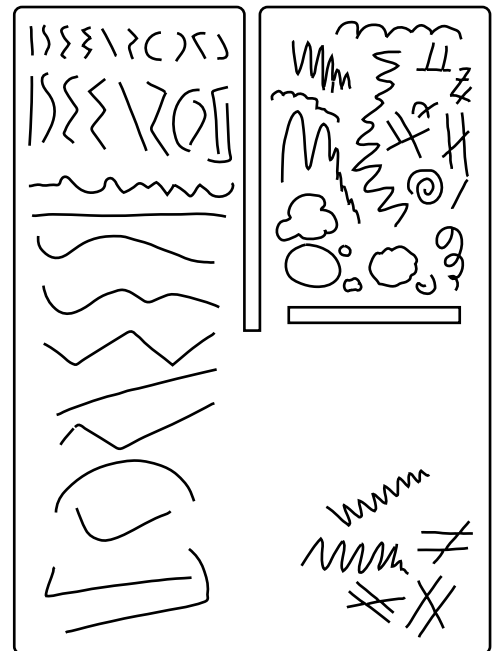

10

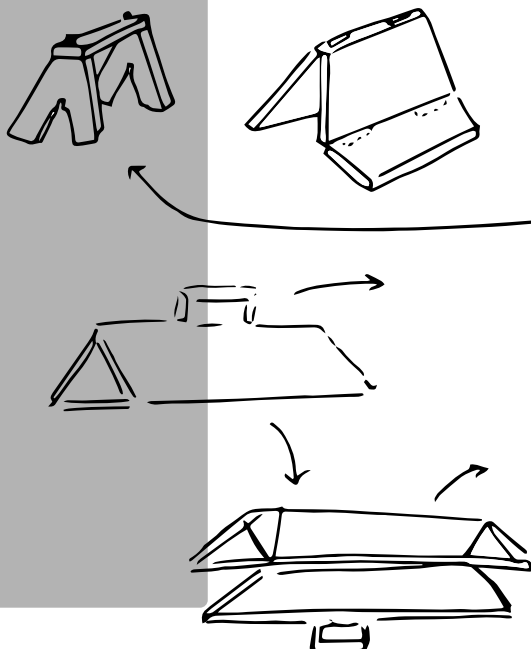



11

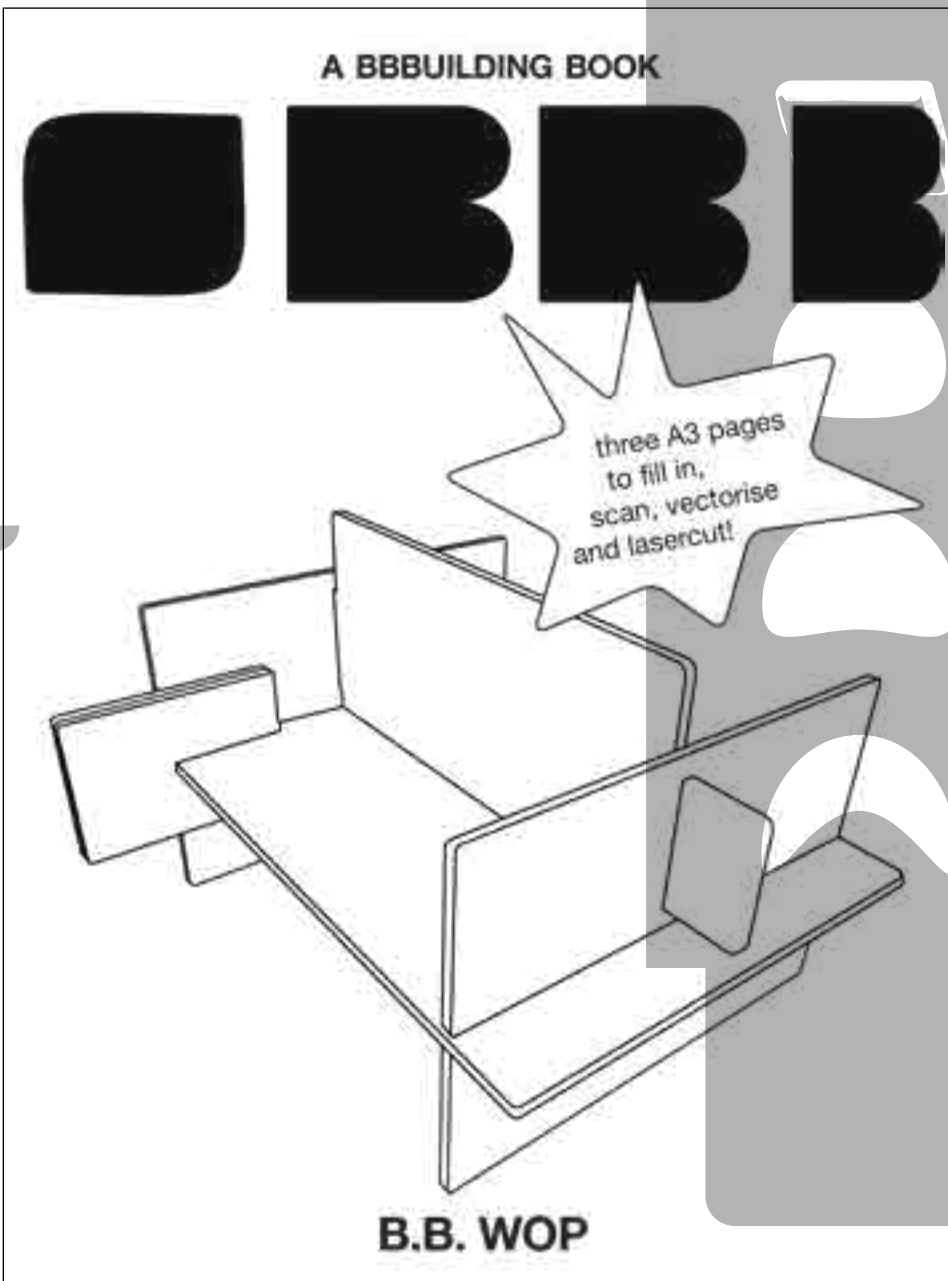
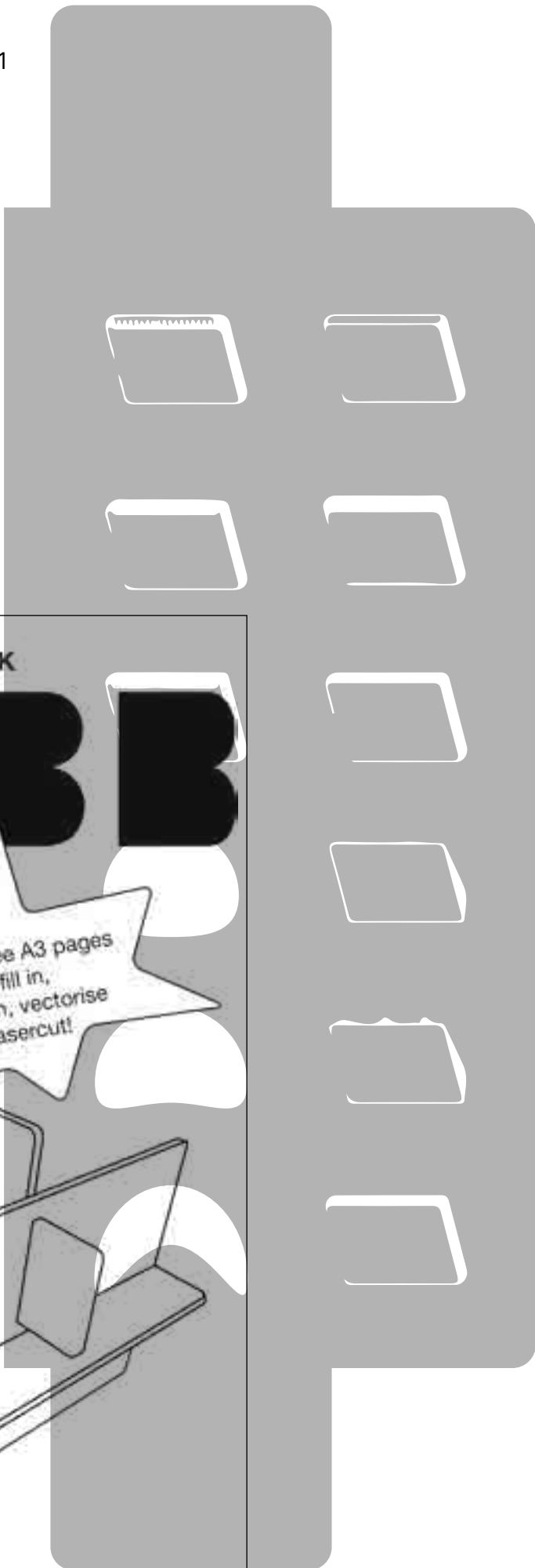
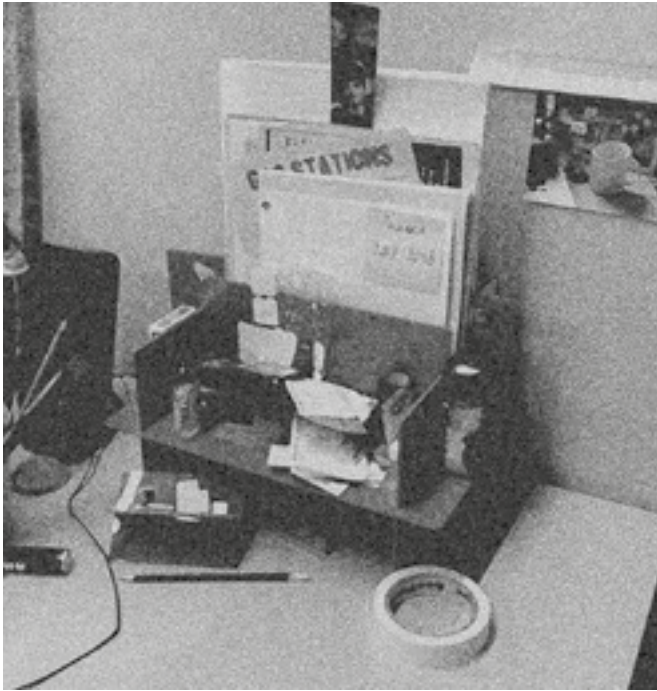

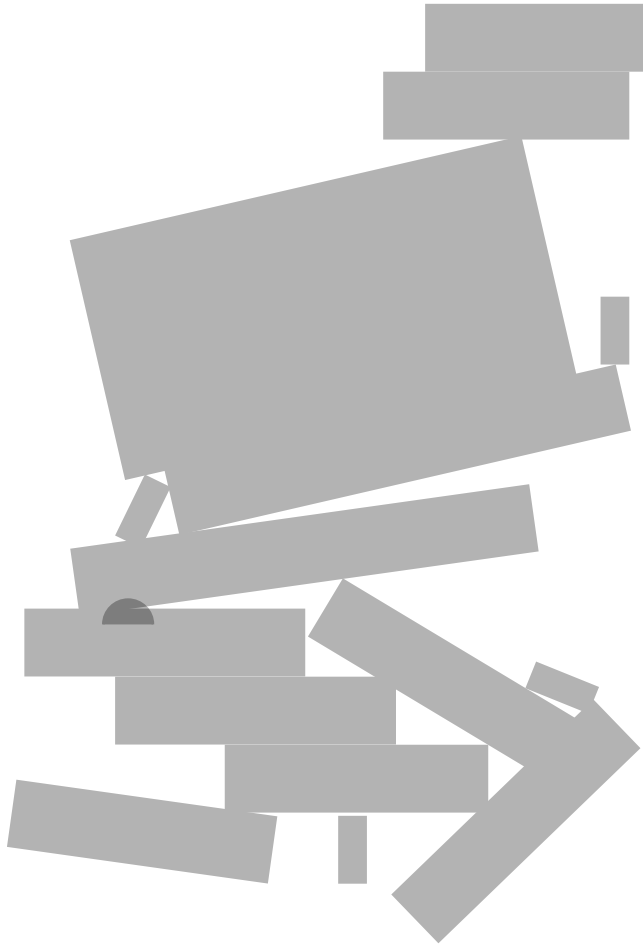

# A stackable kind ↑ ↑

Location: Amsterdam  
Name: V. Osox  
Publication date: 20.02.2023



In December of 2022, I was invited to participate in the first assembly of a new squat in Amsterdam. This moment gathered numerous individuals part of different social, political and/or activist backgrounds, organisations and institutions. Core members of the collective laid out their aims and principles, inviting everyone present to engage in the conversation and participate to the construction of this new space.

A reoccurring subject at the meetings had been to create a welcoming spot for people to hang out, drink coffee or an office, in which books and computers could be made available. A big box full of books was thus still waiting to be put in the open.

Shelves were needed! The opportunity thus presented itself for my contribution to the making of the space. Together with a friend of mine, A (a fellow conceiver of objects who also visited the space on several occasions) we decided to build a pair of shelves. Two at first, enough to host the books in the big box, but design in a way that could easily accommodate growth as the number of books on display would increase.

We decided to make a modular kind of shelf that would be easy to reproduce. It also had to be something we could build in the space itself using the tools and materials already available on the spot. These restrictions were necessary for several reasons. Anyone eager to grow the shelving structure should be able to understand how the shelves were made at a glance.

The same tools and materials we used must always be available in the space itself, as to avoid waste in time and energy to gather tools difficult to access. The shelves needed to adapt and move quickly and independently from us being there, considering that squatted spaces are often defined by urgency and uncertainty.

Following the space's ongoing activities and changes on- and off-line we noticed that the space had no fixed

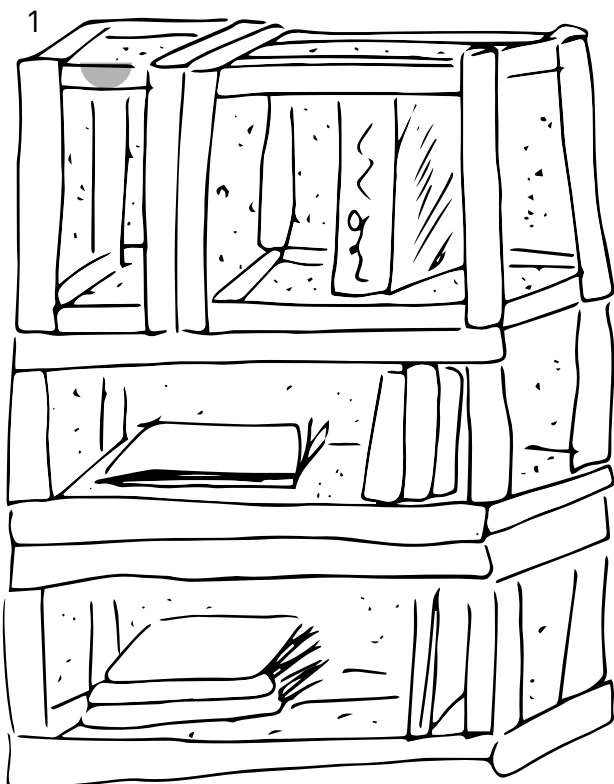

floorpan yet. And maybe would never have one. The capacity to host events and gatherings of all sorts in the communal spaces is indispensable to the space's aims. Because of this constant flow of events and gatherings, the space is in need of a versatile object that would not get in the way of its impermanent configuration.

While looking into potential portable and publication-friendly formats, I came across moving boxes with dimensions (45cm × 47cm × 51cm). Flipped on the side they were close to most required shelving dimensions. So we came up with a design based on standard moving box dimensions. Easy to transport, easy to stack.

At the beginning, we considered a structure based on a garden shed [picture]. Earlier on, the squat had humidity issues in the main communal space. A number of posters and zines in half of the room had already curled up. With this in mind, I thought the shelves should be made waterproof for the publications to stay in shape and easy to move around should other issues of that kind arise. By the time we got to the construction, that issue was resolved allowing us thus to drastically simplify our concept. Still, the box format seemed the most suitable, allowing the books to be both displayed and easily carried around. Also, keeping in mind that this space could be at this point still on the verge of eviction at any time (thankfully the space is still up and running today) the box format seemed perfect from all angles.

After that the design came together quite fast. A and I made a few sketches [add sketches], we sat down together to discuss them and made a few changes. We made sure the lower pieces elevated the shelf a bit for a better grip, also keeping the publications away from direct contact with the floor. Finally, we removed some wood on the upper and lower surface, both to avoid turning the shelf into a closed box and to save up wood. V. Osox was born.

We did not go too much into material specifications for we weren't sure what type of wood would be available to us on the day. This flexibility proved beneficial on the spot. When assembling the shelves with A, we made two changes. First we added small off-cut pieces of wood found on the floor next to scrap wood to the upper slates of wood to add stability, then we realised an extra piece of wood was needed on both sides of the shelves to keep the smaller books from tipping over.

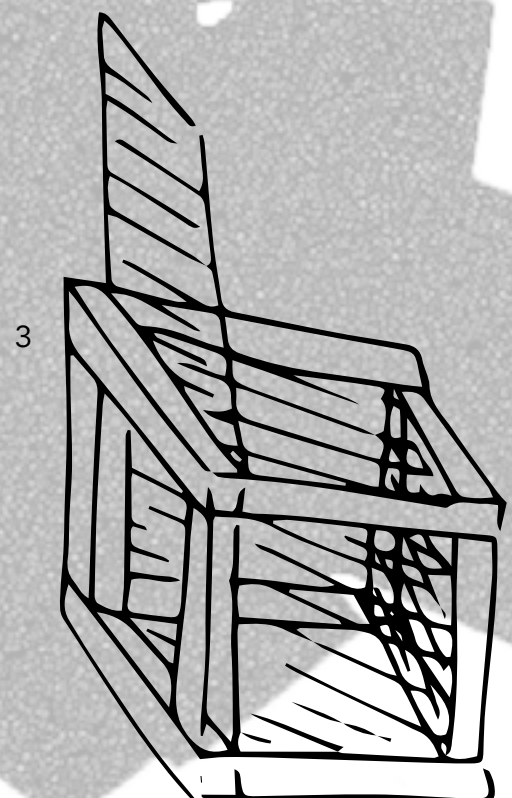
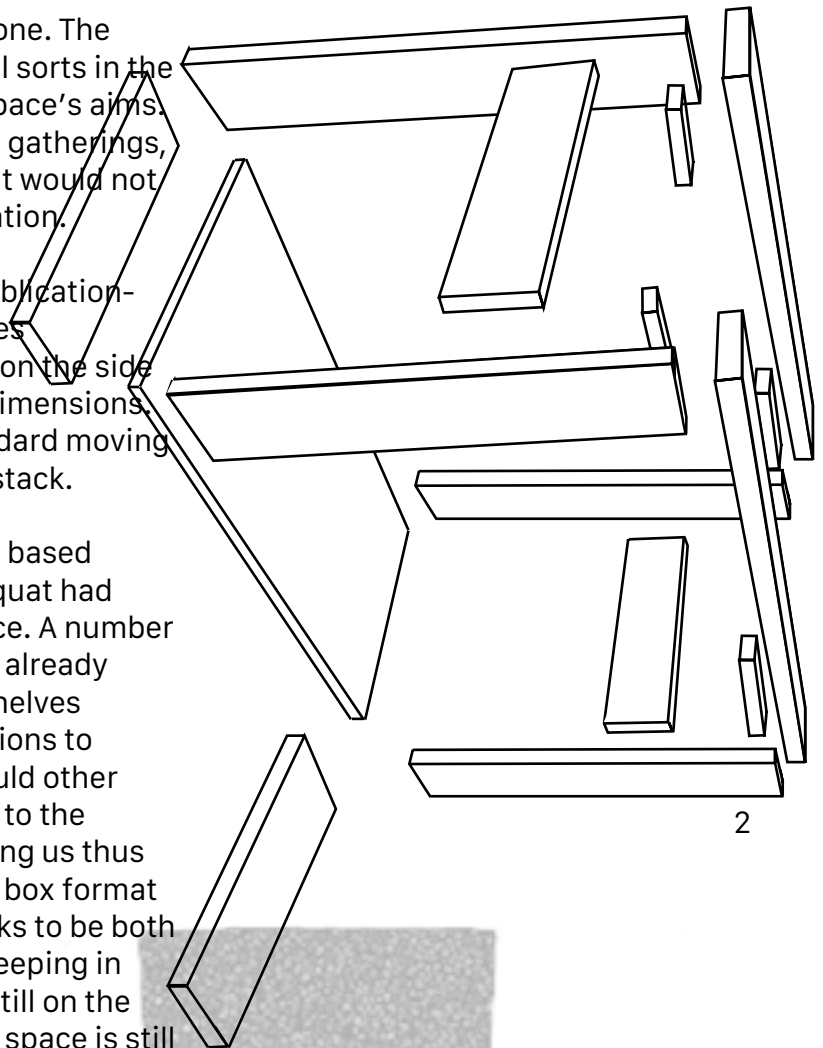

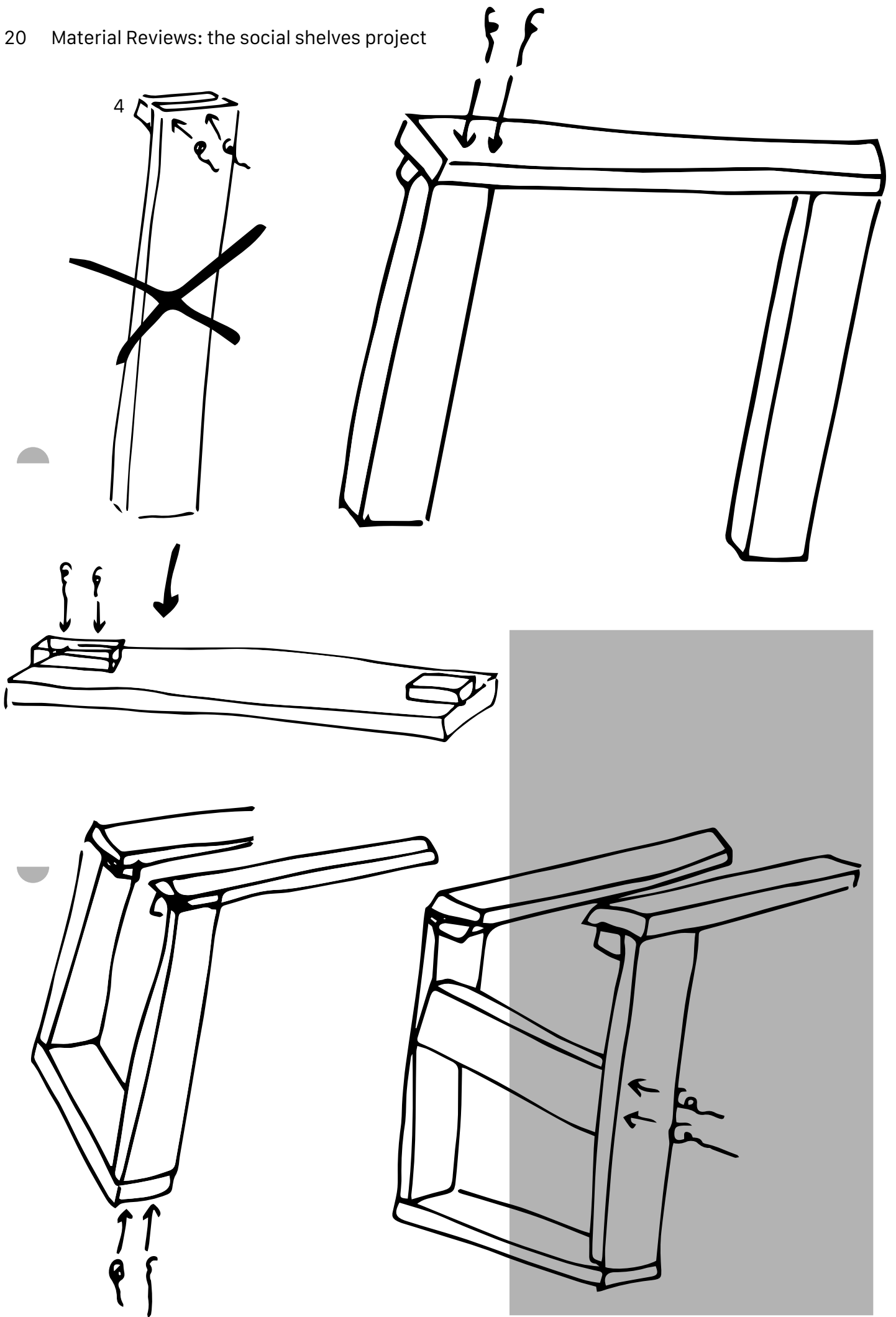

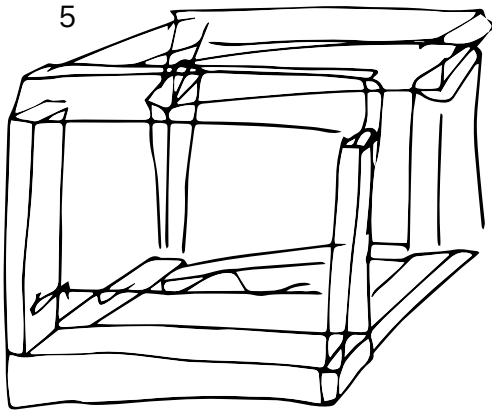

After a long day of work in the main communal space under coloured spotlights, two versions of V. Osox, were ready for use. We played around emptying the big box, all its books neatly fitting onto the shelves. While wondering where to leave the shelves, a member of the collective noted the versatility they offered in use, stackable yes, but also: put side by side, a plank could be added on top of them and bam: a bench!

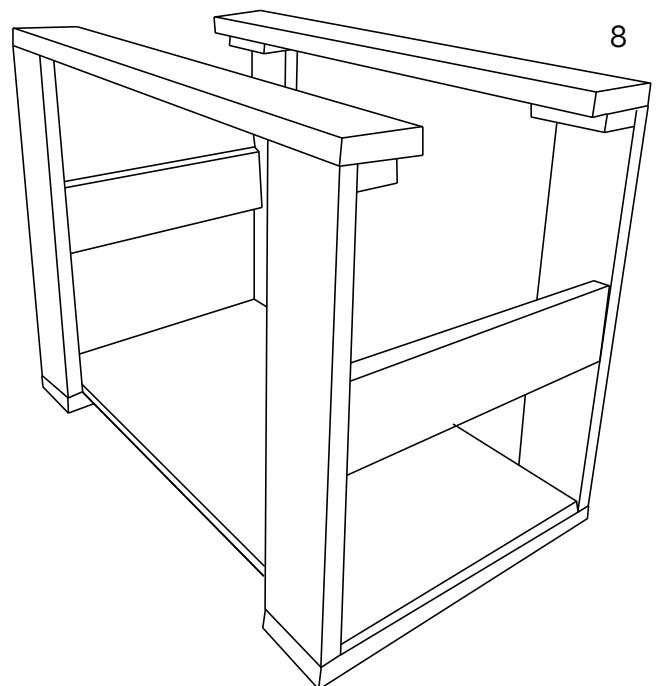
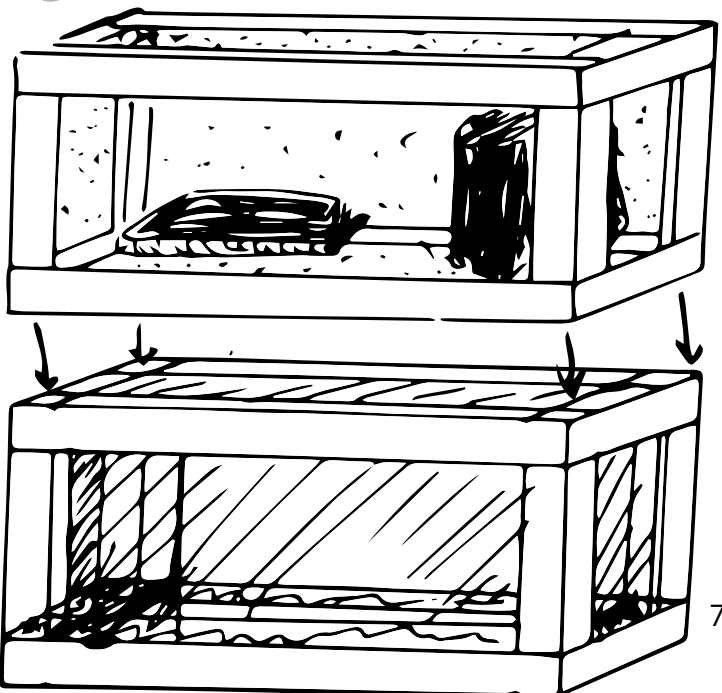
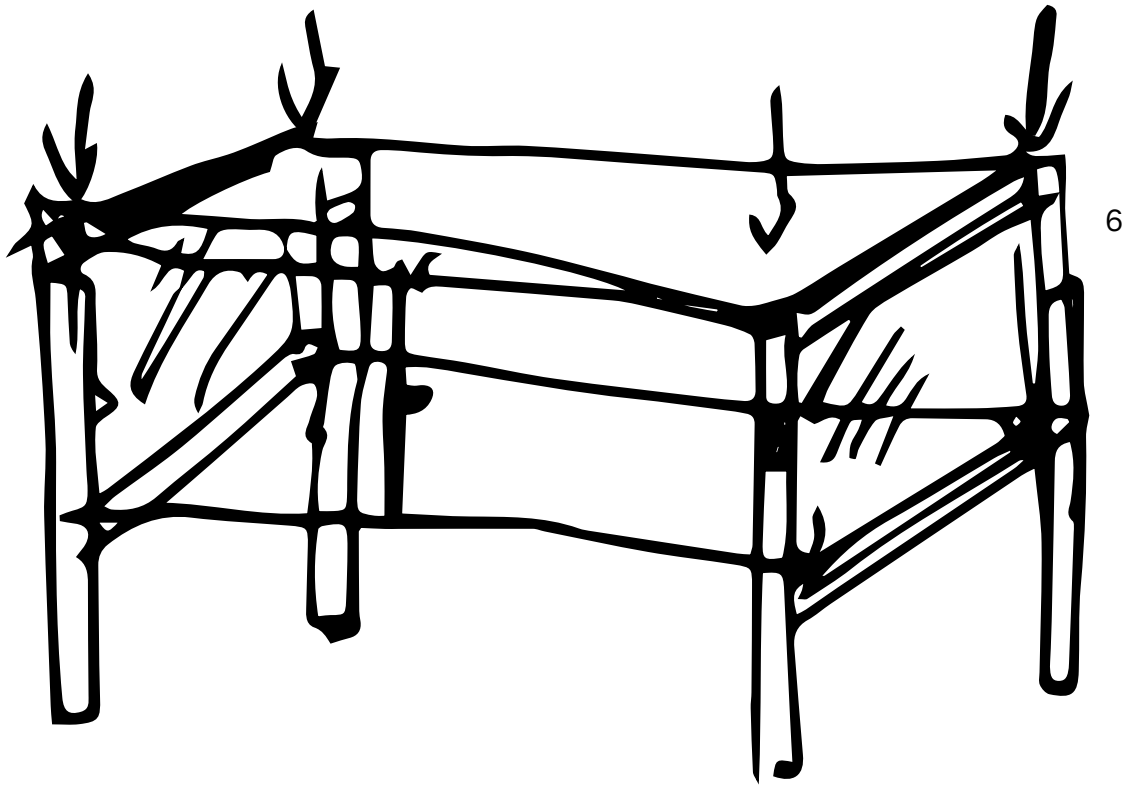



# Synergic antagonists

Location: Rotterdam  
Name: J. Halen  
Publication date: 22.05.2023

The metal in its rawness and strength folds like paper, yet stays in place, unbothered by the weight that falls on it. On the contrary, the weight that sits on it completes it. A few cuts and a fold and J. Halen became the perfect companion for Ji's book collection.

When looking at J. Halen, Ji and I marvelled at its sharp simplicity. This bookend is the most private artefact of the social shelves series. Since the start of our second year of the XPUB master Ji and I had been talking a great lot about the social shelves and book ends in general. Alongside my project we had been discussing a book support issue Ji was experiencing at home. [pictures Ji > ask permission]

In our first year in the XPUB master, Ji and I worked together on the design and production of our second special issue, n°17, This Box Found You for a Reason, A Box in a Box in a Box is a Lootbox. We imagined the publication to be a literal box, made of acrylic, which would be bound with custom stickers enabling people to open and close again the publication as they wished. [picture si17] Both of us share an exciting common interest for publications and their materiality. To design J. Halen we looked back into the stickers that I had designed for the box (which were right under our eyes, stuck on the top of my laptop). All of these stickers were abstract renderings of books being held and opened up [pictures stickers]. We thought it would be interesting to translate one of these perspectives onto our bookend.

Thus the shape of J. Halen is that of an open book. To figure out the size and the perspective we liked the most, I cut out some paper prototypes. Ji tried these at home to see which shape felt best in relation to the space of the file cabinet and the books. Using paper prototypes was a way to interrogate the space with a multitude of possibilities without spending too much time and money on dummies. Once we agreed on the size and the shape, it was time to produce.

As a bookbinder, I often relate to material from my own

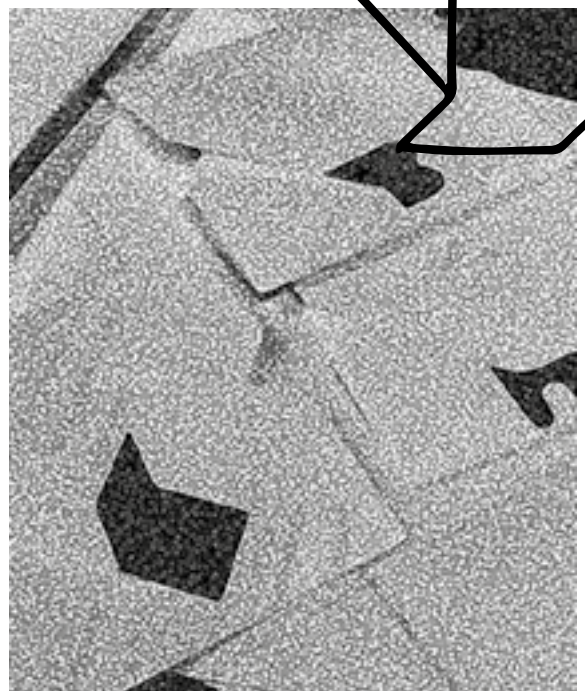
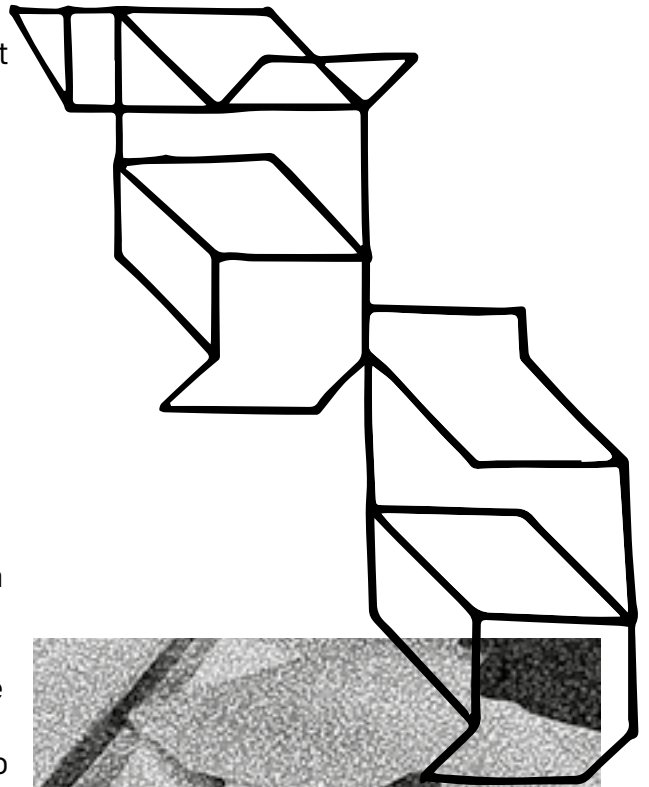
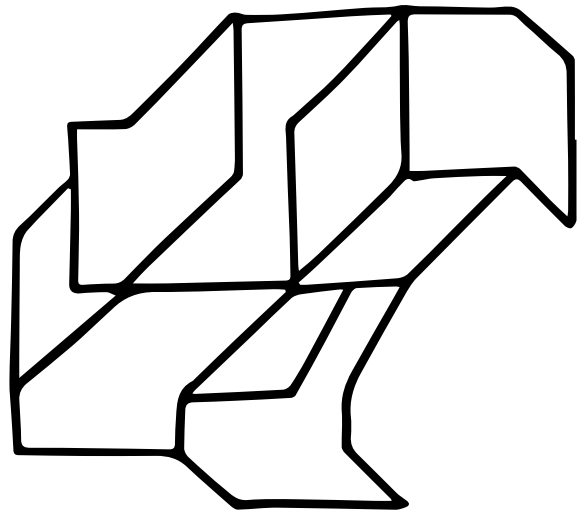

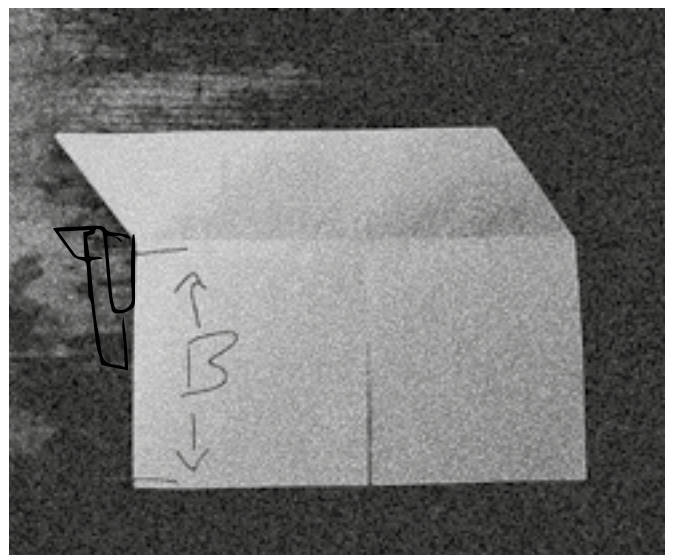
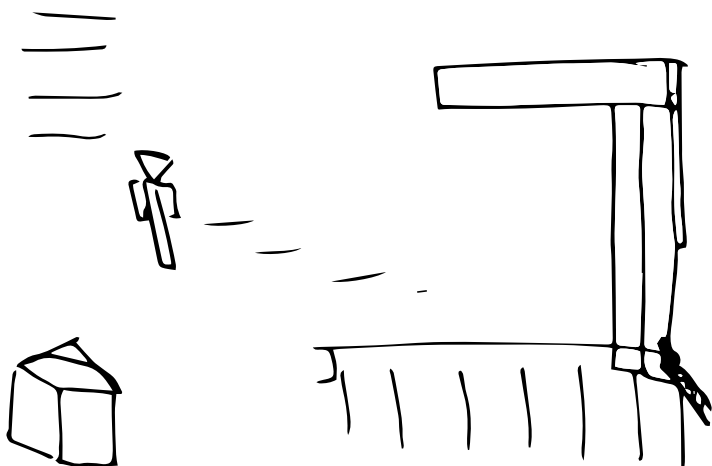
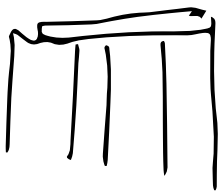
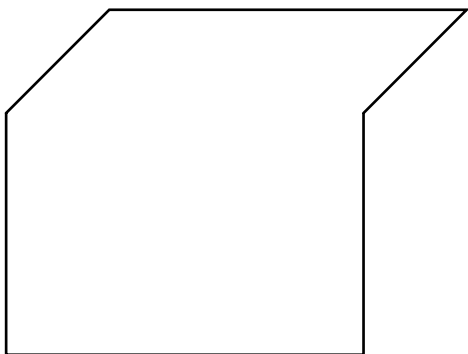
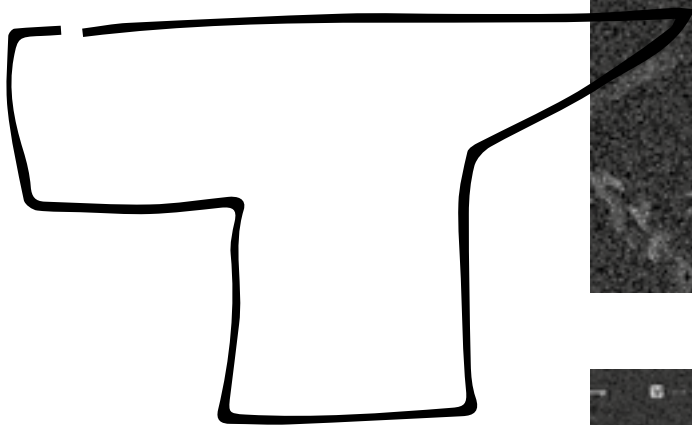
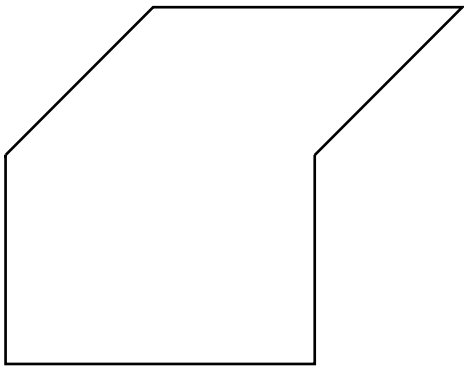



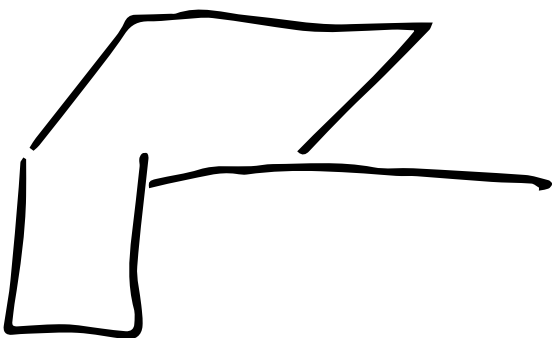
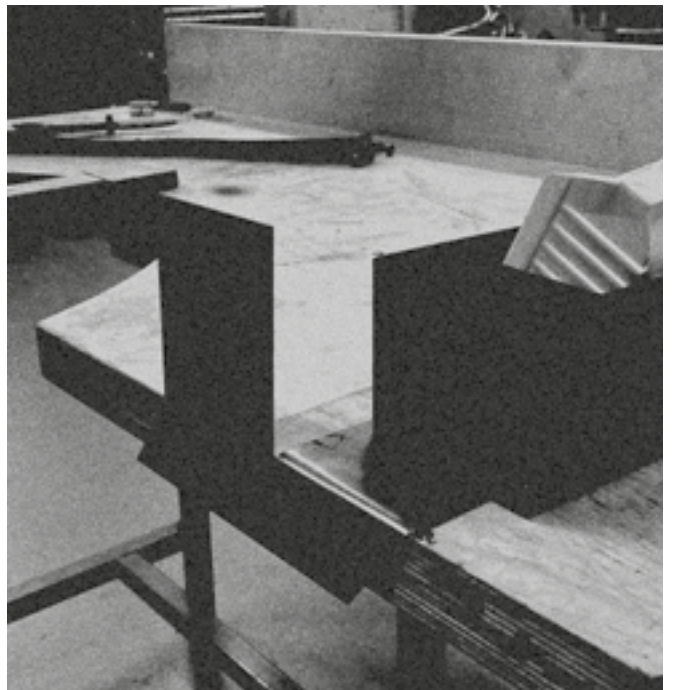
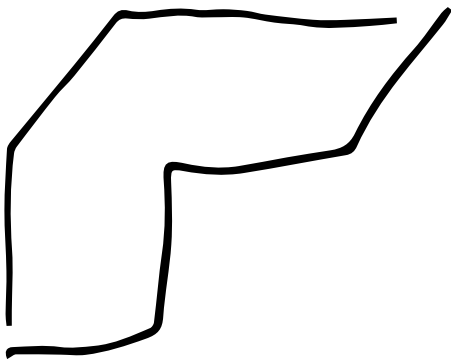
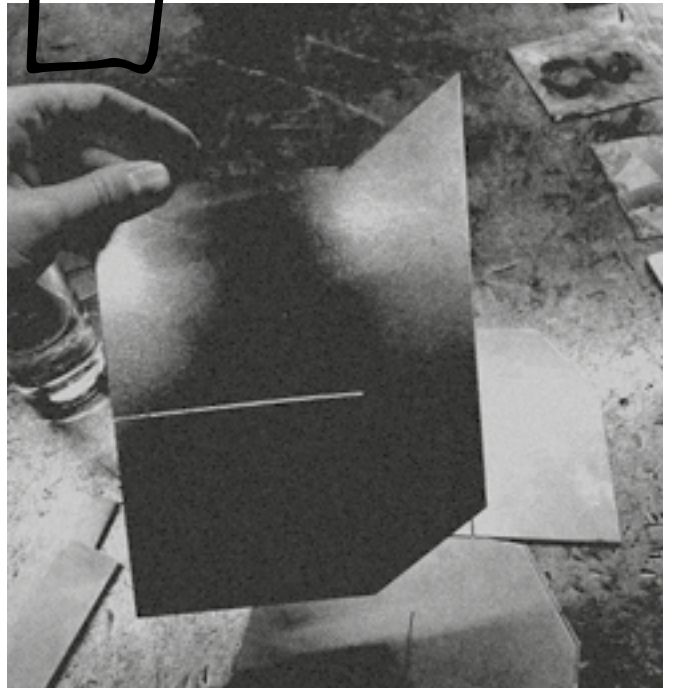

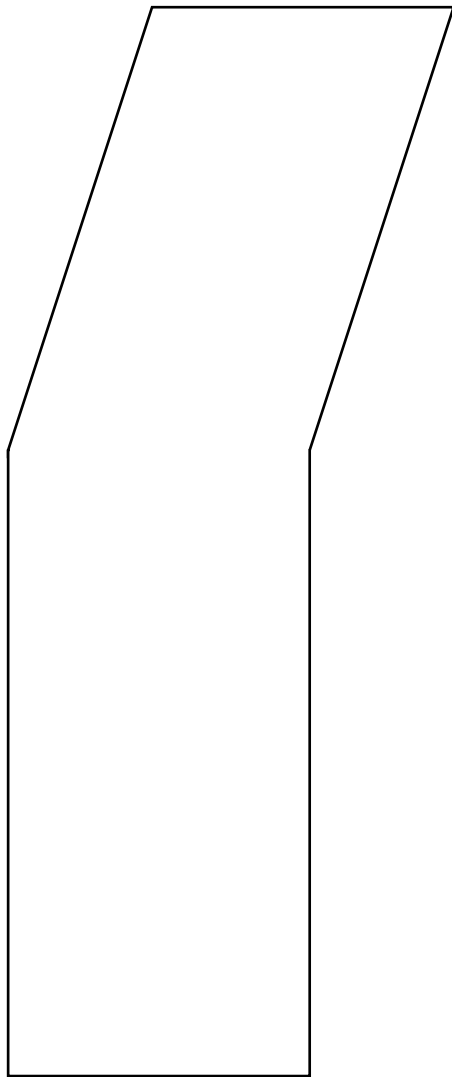

expertise when I learn a new craft. Going into the WDKA metal workshop, I have with me a regular bookend found at a Rataplan in Amsterdam and my paper prototypes. I start considering the different thickness options available for the metal sheet (thickness) just as when I chose paper for a publication.

I started cutting squares into the sheet to the size I need, in a similar way I would pre-cut the spine of a publication before binding it. The middle cut is trickier than I would have thought. It needs to be made manually on a Bandsaw, my two cuts per bookend are (almost) straight. To try-out, I make one bookend's perspective mirror the others. Soon I realise this choice makes a big difference in the filing of the metal. The clamps in the metal station available to hold the bookends are quite big and uneven; their unusual shape add a layer of complication to the smoothening process that followed. Some sides are harder to reach than others.

I made J. Halen in such a way, that its first fold holds the books upright thanks to their own weight, while the second fold also pushes back on the part below against the drawer case. This prevents the books from falling simply by the force applied in opposite directions; our bookend becoming the perfect facilitator to enable this cohabitation. [sketches]

Ji's file cabinet had no end that could hold back books from falling; nor a space under this metal block (unlike wooden planks shelves) [picture] to slide or hook something to prevent the books from tipping over. On this cabinet, a regular bookend would easily be overpowered and fall if the row of books were to lose balance. What I first thought was a scale issue, meaning that I considered the bookend simply needed to be made taller, we quickly discovered was actually a support issue. A bookend works as follows: the weight of the publication(s) that leans on its flat edge in a 90° angle enables both the bookend and the publication(s) to stand upright. [pictures] They complete each other in what is otherwise an awkward position for those objects to hold separately.

Yes, this is what J. Halen needed. Not only an upright surface to hold the books in place, but also a downright one that would prevent the books from tipping over, supporting them, again, with their own weight. [sketches] Funnily enough, J. Halen only stands upright when hosting its book guest. When put the other way it becomes another kind of bookend, but as Ji wanted it, it only holds when being held.

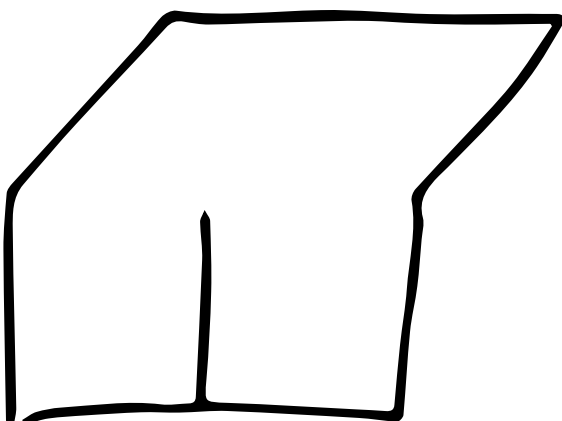

# J. Halen

Viertes soziales Regale, Edelstahl, früher Buchstützte

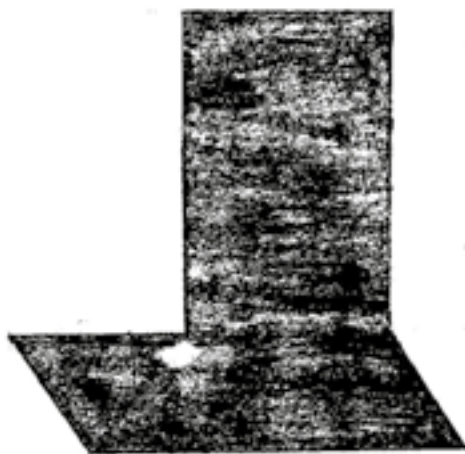
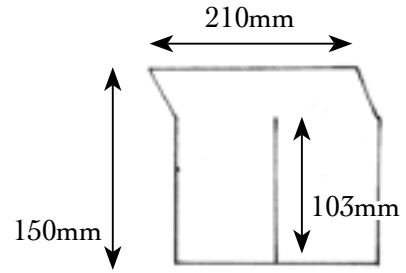
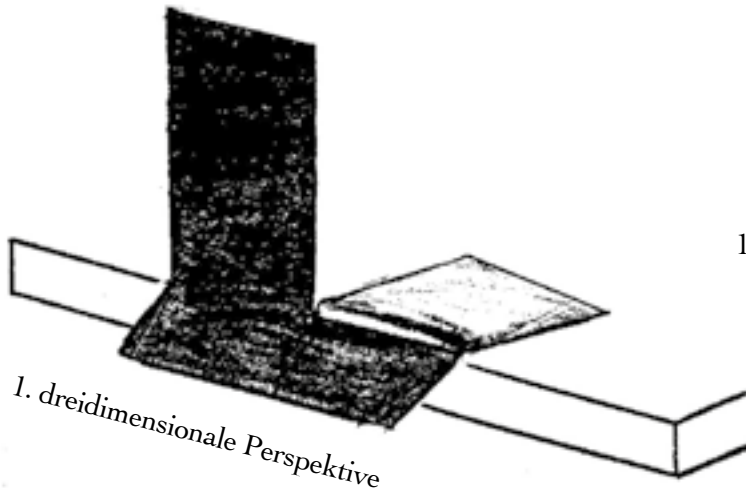

# The bench sitter's companion

Location: Amsterdam  
Name: P. Enches  
Publication date: 12.06.2023

When I started this project, I wondered: what is the difference between a social shelf and a minibieb? Probably not much.

[add definition minibieb + pictures]

Minibiebs can be found across the Netherlands. They seem to sprout in every neighbourhoods responding to an urge to circulate, mostly, books, create a sense of community and avoid waste.

A simple invitation to make a halt as you pass by. You can get to know your neighbours a bit more through those 'passed on' books: do they have kids? What kind of studies did they do? What kind of language can they read? Are those modern or old editions?

They fascinate me in their simplicity. Often, they seem to be a prolongation into the street of the home to which they are attached. The bookshelf, a classic piece of indoors furniture has been turned into an outdoors one. The vernacular shelving system turned inside out now responds to two needs rather than one: not just to store but also to keep dry.

Minibiebs also constitute the unwanted libraries of our neighbourhoods in a way. Their desirability can be witnessed by their state. Some books seem to stay in the minibieb until they have to be disregarded, weathered to pieces by the changing seasons. Some books disappear instantly after you've put them out. I cherish these invitations to stop and gaze dearly during my walks.

A main difference between my social shelves project and minibiebs is mobility. And modularity probably. Minibiebs are specific to one location, often nail to a wall. They sprout in neighbourhoods that can sustain, use and care for them. In this sense they are also true to several features of the social shelf project regarding accessibility and sustainability. They invite sharing and re-using instead of discarding.

	○	
	○	
	○	
	○	

Minibiebs are already very close to our homes, and so I wondered how I could make a gift to the public space that wouldn't prolongate my home to the streets but truly become part of the outdoors. I wanted to invite people outdoors, so that they could sit outside but with a sense of privacy.

A singular trope of the public space, to me, is the public bench. Quickly I started getting excited by the idea of 'contaminating' (in the sense that the bench would be slightly disfigured compared to its original design) a public bench with a 'minibieb'-like extension, P. Enches. [sketches]

Next to their obviously community building aspect minibiebs also blur the threshold between private and public. Their users or instigators seem to attempt a prolongation of their privacy in the public space.

One of my favourite public bench has that very recognisable curve [attach picture bench] which embodies my romantic expectation of what a bench in the public ought to look like. Smooth, made of wood, comfortable both to sit on and lie on. On the contrary a lot of modern designs nowadays [picture] are made in such a way that you cannot comfortably sit or lay on them for a long time. A sad illustration of the ways people are pushed out of the public space, which is no longer considered as a space to linger in anymore but only becomes a space to transit through.

Those benches I chose distinguish themselves by this curve, their metal legs, wooden beams and washed out green paint. At this point, this shelf is the last one I will build as part of my series. My aspiration for reproducibility led me to reduce my set of tools to a handsaw, a hammer and nails [attach pics tools, no background]. As for the materials, given the uncertainty around the life expectation of an illegitimate public installation, I decided to only use recycled wood. [pictures]

I have no certainty as to the viability of this particular prototype in the public space. What is certain is that it will sooner or later be made obsolete and discarded. So I need an object that can be made anew easily, using a similar method. Only improving maybe certain material and binding choices in the reproductive process.

P. Enches mimics the slate aspect of the bench,

making use of this aesthetical feature and turning it into a technical one. In order to easily install, move and remove the shelf, the object is constituted of three pieces: two sides that can be easily slid into the bench plus a roof and walls that can always come off the two sides once installed. [technical drawings] The object that is built of maybe five or six different woods is given a 'final' look with a base of grey paint and a second layer of a mix of green acrylic (all paint used are leftovers from past projects) to make the object blend with the bench better and make it more waterproof. [pictures]



# a. tool in one hand a. story in another

The making of each of the five shelves was a stage in a learning curve which led me to be more critical of the tools I use, the choices I make in different contexts. Each shelf's narrative influenced how I would engage with the next one. The material 'mistakes' I made taught me to plan better or less, create design that were more understandable, easier to reproduce and to use.

All the shelves are now where they belong. They are ambassadors of a new material landscape, in which objects are considered from a social angle and not as mere products anymore.

Showing these objects out of context, would make me their designer-author, when I feel more and more that I only facilitated their encounter with their human counterparts in given contexts. I succeeded in producing objects that belong to the space for which they are made. Yet, their temporality is as relevant as their practicality for their acknowledge that space, people and contexts shift, sometimes drastically, sometimes slowly. And to create intelligible designs, enables those space, people and contexts to have agency in conceiving those small objects they make use of, objects we have all around us.

I aim to produce things that prioritise visual intelligibility over opaque technological prowess. My prototypes have thus drastically changed over the course of the project. Each of these objects are learning objects, each a draft of my research around what makes a social shelf.

I started this project with a social shelf for the XPUB entity and ended it this year with a 'social shelf' for my group, with my group. This last social shelf is the one built for the context of this temporary show. An object, or objects that will serve its purpose for only a few days, four to be precise. How does one build something for a few days' exhibition without creating waste and superfluous items?

The show's social shelf will be like showing the last draft of the work-in-progress in regard to this specific project. For it has not ended yet.

To be coherent with our material choice and building so far, the logic of the graduation show installation would be to succeed in creating no waste. Re-using 'old' materials is already one thing. Amazingly, those materials already come from a similar background, have been used and donated by projects having similar values. That is one thing.

Now, how do we want to use those materials as not to make them immediately obsolete? How can they be used in a way that they could survive the show and not be disregarded immediately after the end of the 'exhibition'?

To respond to the needs of this specific context we had the opportunity to elongate the life of objects already used in another 'exhibition' set-up. Sustainability in objects can be that, to re-use already made object, instead of stubbornly producing more. The materials we use to make the installation for the show come from a generous donation of leftover materials of furniture (including a grand shelving installation) and borrowed pedestals used at BAK for the Ultradependent Public School. [credit]

This new context in which to mediate the encounter of a space and a shelving system (in this case overall support infrastructure) is an opportunity to push even further the experience of the social shelf project to put into practice the things we learned.

Going back through this whole process you might understand better why all those shelves do not constitute 'end products' per se, but show the many steps in a research towards a better understanding of objects around us and ways we could engage with them in a more responsible and sustainable manner.

At the moment we want to use all those 'leftover' materials and borrowed pedestals in a way that we do not alter their material integrity. The pieces should remain mostly uncut, maybe some holes can be drilled into them for attachment purposes but the assemblage and superposition of our different materials should as much as possible be what motivates the structure to hold together, rather than fixing it into a permanent new structure that would have no way to belong in any other context and would have to be discarded.



Material Reviews: the social shelves project 2022-2023  
Experimental Publishing (XPUB) Department, Piet Zwart Institute  
Rotterdam

WRITTEN BY  
Gersande Schellinx

Special thanks to Clara Balaguer, Supisara Burapachaisri, Manetta Berends, Chloé Delchini, Oliver Feghali, Miquel Hervás Gómez, Carmen Gray, Jian Haake, Chaeyoung Kim, Joseph Knierzinger, Dasha Leontieva, Ott Metusala, Harriet Rose Motley, Michael Murtaugh, Aurélie Noudelmann, Finn Overdevest, Emma Prato, Alec Schellinx, Harold Schellinx, Ilya Stasevich and all the ones who helped the social shelves come to life.

#### CREATIVE COMMONS

The text in this book might be copied, distributed and transmitted based on the Creative Commons Attribution-Noncommercial-NoDerivatives 4.0 International license (CC BY-NC-ND 4.0).

#### YOU ARE FREE TO:

**SHARE** — copy and redistribute the material in any medium or format  
The licensor cannot revoke these freedoms as long as you follow the license terms.

Under the following terms:

**ATTRIBUTION** — You must give appropriate credit, provide a link to the license, and indicate if changes were made. You may do so in any reasonable manner, but not in any way that suggests the licensor endorses you or your use.

**NonCommercial** — You may not use the material for commercial purposes.

**NODERIVATIVES** — If you remix, transform, or build upon the material, you may not distribute the modified material.

Learn more: <https://creativecommons.org/licenses/by-nc-nd/4.0/legalcode>  
The images are a collection of personal pictures, drawings and sketches, as much as found pictures, documents and screenshots. We apologise for any material used without proper accreditation. If you would like to be credited in future editions or claim any legal rights please contact the writer at [gersandeschellinx@gmail.com](mailto:gersandeschellinx@gmail.com)



## 34 Material Reviews: the social shelves project

The images are a collection of personal pictures, drawings and sketches, as much as found pictures, documents and screenshots. We apologise for any material used without proper accreditation. If you would like to be credited in future editions or claim any legal rights please contact the writer at gersandeschellinx@gmail.com



Disclaimer [p.2]

1, 2, 3 & 4: some sketches of dream modular shelves in glass

Discussion with H [p.3,4]

where are the social shelves [p.3,4]

A 'seamless' design

1   
2  
3  
4  
5  
6  
7  
8  
9  
10  
11  
12  
13  
14  
15  
16  
17  
18  
19   
20  
21  
22  
23  
24  
25  
26

420 × 297 times three

A stackable kind

Synergic antagonists

The bench sitter's companion

a tool in one hand a story in another

